

















PARTING AND GROOVING TOOLS





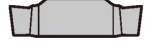









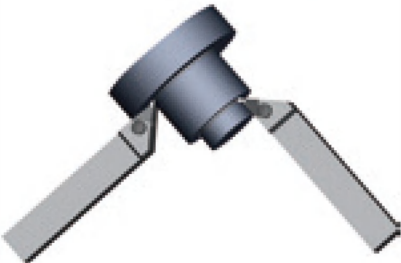

Parting and grooving tools overview	B142-B143
Parting, grooving and profiling inserts code key	B148
Parting, grooving and profiling inserts	B149-B154
External and face cutting tools code key	B155
Parting, grooving tools	B156-B163
Internal cutting tools code key	B164
Internal grooving and turning tools	B165
Recommended cutting parameters for parting and grooving	B166
General information	B167

Turning

● Parting and grooving tools overview

Machining application	Machining type	Applicable tools	Corresponding inserts	Tool's feature and parameters
External machining	Parting	The little squirrel series QZ□□+QE□□  B160-B161	Parting inserts ZP□S□□ 	<ul style="list-style-type: none"> Assemble structure of parting blade and holder, good rigidity and parting range is adjustable. The maximum parting diameter is 4.724inch.
		The little squirrel series QE□□R/L  B156-B157	ZP□D□□  ZP□S□ 	<ul style="list-style-type: none"> Inserts have 3d chipbreaker, small cutting force, good performance on chip breaking. The maximum parting diameter is 2.362inch.
	Grooving and turning	The little squirrel series QE□□R/L  B156-B157	Double cutting edges for parting ZT□D□□  Profile turning ZR□D□□  Single cutting edge for deep grooving ZT□S□□ 	<ul style="list-style-type: none"> Various applications can be realised by one single tool, installed with different inserts for grooving, profiling and parting. It reduces the tool category. Installed with grooving inserts, the tool realizes grooving and transverse cutting. It's multifunction tool. The maximum slot depth can be machined is 1.181inch.
	Precise grooving	The little squirrel series QECD  B158	Precise grooving ZT□D□□-EG  Edge width 0.047~0.094inch	<ul style="list-style-type: none"> Grinded insert, used for precise grooving. Edge width can be any size between 0.039~0.256inch according to customers, requirement. ZT□D□□-EG inserts: When edge width is between 0.047~0.094inch, the maximum cutting depth is 0.098inch; When edge width is >0.094~0.256inch, the maximum cutting depth is 0.866inch.
		The little squirrel series QE□□R/L  B156-B157	Precise grooving ZT□D□□-EG  Edge width 0.039~0.256inch	

B

Machining application	Machining type	Applicable tools	Corresponding inserts	Tool's feature and parameters
Internal machining	Grooving and turning 	The little squirrel series C□□□□□-Q□DR/L 	Grooving, Turning ZT□□□□  Profile turning ZR□□□□ 	<ul style="list-style-type: none"> By installing different inserts for grooving and profiling, one single tool realizes various applications, it reduce the tool category. The maximum slot depth can be machined is 0.512inch. The minimum diameter can be machined is 1.063inch.
		B165		
End machining	Grooving and turning 	The little squirrel series QF□□□□H 	Grooving, Turning ZT□□□□  Profile turning ZR□□□□ 	<ul style="list-style-type: none"> By installing different inserts as for grooving and profiling, one single tool realizes various applications, it reduces the tool category. Grooving diameter 1.890~15.748inch. Grooving depth 0.394~1.181inch.
		B161-B162		
Recess machining	Recess and turning 	The little squirrel series QX□□□□□□ 	Grooving, Turning ZT□□□□  Profile turning ZR□□□□ 	<ul style="list-style-type: none"> 90°toolholder, top clamping By installing different inserts as for grooving and profiling, one single tool realizes various applications, it reduce the tool category. Grooving diameter 1.890~15.748inch. Grooving depth 0.394~1.181inch.
		B163		
Tools for aviation and aerospace industries	External machining 	The little squirrel series QE□□□□-□□R/L 	The little squirrel series ZIG□□□  The little squirrel series ZIMF□□ 	<ul style="list-style-type: none"> V-type locating, top clamping, precise locating, safe clamping. Normal square-ended inserts and precise square-ended inserts are suitable for adhesive. materials hard to machine such as Ni-base hightemperature alloy, Ti alloy and stainless steel, etc.
		B158		

Little squirrel
series

-EG

Precise grooving and profile turning inserts

Special chipbreaker design, suitable for precise grooving of low-carbon steel, stainless steel, adhesive materials and non-ferrous metal.

-EG Precise grooving inserts

The edge width can be alternative between 0.039-0.256inch according to your requirements.

0.039~0.094inch

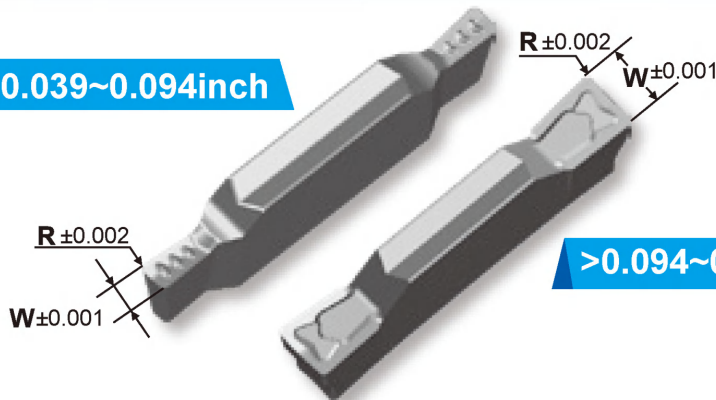

>0.094~0.256inch

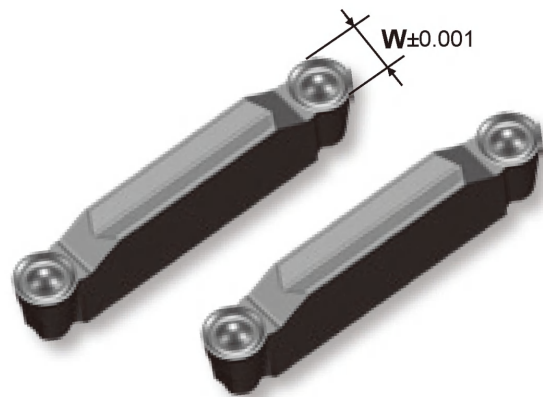

-EG Precise profile turning inserts

The Little Squirrel series precise profiling and turning inserts are mainly used for Precise grooving and profiling.

The tolerance of the edge width S of precise grooving and profiling inserts can reach ± 0.001 . Inserts can also be mounted on the corresponding specifications of original tool series.

The width of the Little Squirrel series precise grooving inserts can be alternative between 0.039inch to 0.256inch, which means products with any edge width or nose radius can be provided according to customers' requirements. The inserts are mainly used for precise grooving, such as sealing slot and locating slot, etc.

-MG Little squirrel series

-MG Series Chipbreaker

Suitable for parting, grooving, profiling, and turning. Good chip control and chip evacuation for good surface finish.

Insert design allows for use in many applications with need for fewer insert grades and configurations.

Inserts with the same cutting edge width can be used with different holders. Standardization with fewer inserts for internal, external, grooving and turning reduces tool inventory and tool management cost.

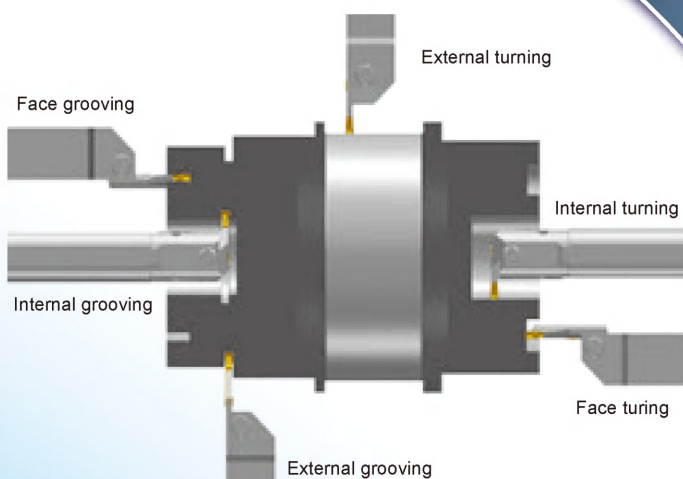

20% reduction in cutting force and reduced vibration.

Unique design of parting insert

- Insert uses specially designed flank to reduce cutting resistance by 20% with reduced machined surface ovality.
- A special design of the cutting edge requires less rigidity of machine. Older and lower horsepower machines can be used more productively.



Little-Squirrel Series

Profile turning inserts for parting of aviation titanium alloy and high-temperature alloy

-NF

Single-headed precision profile turning inserts

Sharp edge, small cutting force, good surface quality;
Indexing accuracy reaches ± 0.001 inch, safe and stable clamping;
Mainly applied in finishing of high-temperature alloy, titanium alloy.



-NM

Precision profile turning inserts

Sharp edge, small cutting force, good surface quality;
Indexing accuracy reaches ± 0.001 inch;
Highly economical, two edges available;
Compatible with little squirrel tool holder, suitable for small depth profile finishing and semi-finishing of high-temperature alloy and Ti-alloy.



-SM

Single-headed groove turning inserts

Straight edge, excellent surface quality;
Sharp edge, smaller cutting force;
Good chip breaking;
Mainly used for rough machining of high-temperature alloy and titanium alloy.

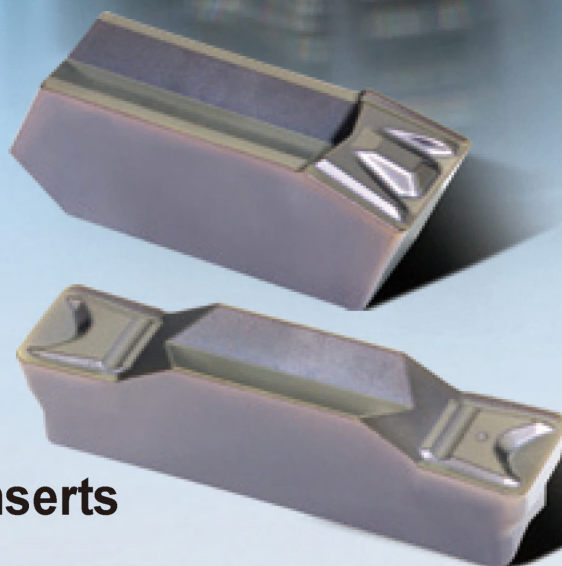

-MM

Straight edge groove turning inserts

High edge strength, sharp edge;
Highly economical, two edges available, compatible with little squirrel tool holder;
With special grades, suitable for roughing with small cutting depths of high-temperature alloy and titanium alloy.

Case

Insert: YBG105/ZIMF604N-SM
Hardness of workpiece material: GH4169 (HB380)
Cutting data: $V=150$ SFPM, $f=0.008$ in/r
Coolant: water



Products of company A



YBG105/ZIMF604N-SM

Conclusion: Under the same conditions, chip breaking performance is better and the time for stopping the removal of long winding chips is reduced.

Parting, grooving and profiling inserts code key

Application of inserts

- ZP > Parting
- ZR > Profile machining
- ZT > Grooving and turning

Code of locating slot

Code of locating slot	A	B	E	F	G	H	K
Width of cutting edge	0.059	0.079	0.098	0.118	0.157	0.197	0.236

Number of cutting edge

- S > Single cutting edge
- D > Double cutting edges

ZP G D 04 04 - M G

Width of cutting edge



01=0.059"	02=0.079"
025=0.098"	05=0.197"
03=0.118"	06=0.236"
04=0.157"	

Nose radius

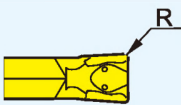

02=0.008"	04=0.016"
03=0.012"	06=0.236"

Tolerances

- M > M class tolerance
- E > E class tolerance

Chipbreaker code

- G > General chip-breakers, suitable for all kinds of machined materials
- F > Special chip-breakers

Parting inserts

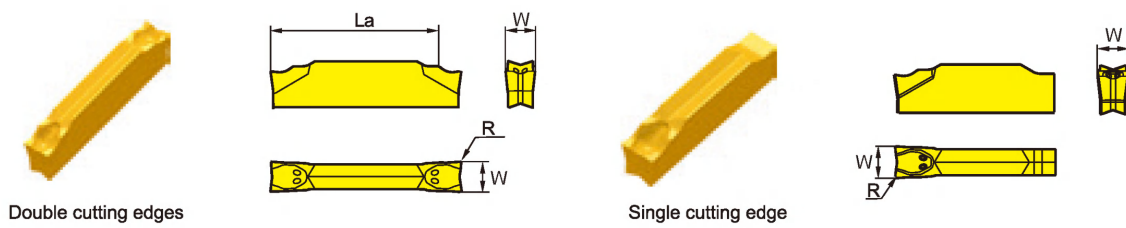

Double cutting edges

Single cutting edge

Type	Dimension(inch)			Grade								
	W ₀ ^{+0.004}	R±0.002	La _{max}	P		M		K				
				YBG202	YBG302	YBG202	YBG302	YD201	YBG302	YD201	YBG102	
Double cutting edges	ZPAD01502-MG	0.059	0.008	0.472		○		○		○		
	ZPBD0202-MG	0.079	0.008	0.551		○		○		○		
	ZPED02502-MG	0.098	0.008	0.670	○	●	○	●		●		
	ZPFD0302-MG	0.118	0.008	0.670		○		○		○		
	ZPGD0402-MG	0.157	0.008	0.866		○		○		○		
	ZPHD0503-MG	0.197	0.012	0.866		○		○		○		
	ZPKD0604-MG	0.236	0.016	0.866		○		○		○		
Single cutting edge	ZPES02502-MG	0.098	0.008	--	○	●	○	●		●		
	ZPFS0302-MG	0.118	0.008	--		○		○		○		
	ZPGS0402-MG	0.157	0.008	--		○		○		○		
	ZPHS0503-MG	0.197	0.012	--		○		○		○		
	ZPKS0604-MG	0.236	0.016	--		○		○		○		

Insert with single cutting edge only be used to parting blade

● Always stock available ○ Produce according to order

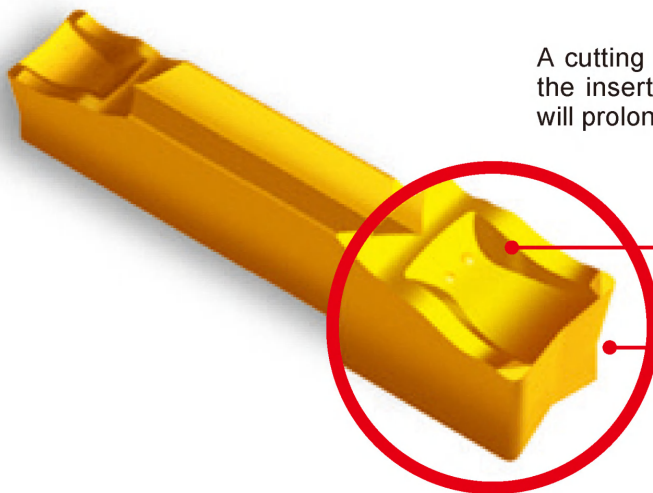

A cutting speed reduction of 30% is preferred when the insert is approaching the workpiece. This action will prolong tool life.

Enhanced chipbreaker design improves chip control.

20% cutting force reduction and reduced vibrations.

QE□□R/L



Applicable tool

Grooving, turning inserts

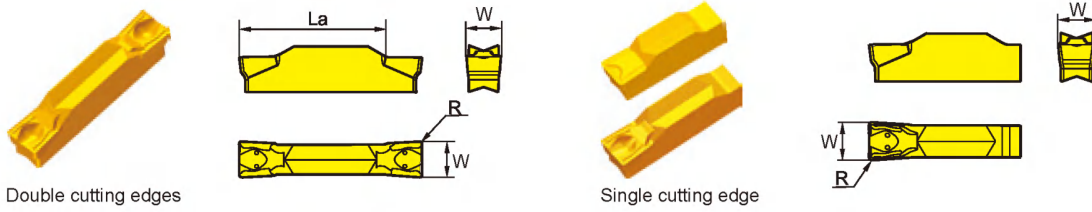

Type	Dimension(inch)			Grade								
	W ₀ ^{+0.004}	R±0.002	La _{max}	P		M			K			
				YBG202	YBG302	YBG202	YBG302	YD201	YBG302	YD201	YBG102	
Double cutting edges												
ZTED02503-MG	0.098	0.012	0.670	●	●	●	●			●		
ZTFD0303-MG	0.118	0.012	0.670	●	●	●	●			●		
ZTGD0404-MG	0.157	0.016	0.866	●	●	●	●			●		
ZTHD0504-MG	0.197	0.016	0.866	●	●	●	●			●		
ZTKD0608-MG	0.236	0.031	0.866	●	●	●	●			●		
Single cutting edge												
ZTHS0504-MG	0.197	0.016	--	○	○	○	○			○		
ZTKS0608-MG	0.236	0.031	--	○	○	○	○			○		

● Always stock available ○ Produce according to order

Grooving, turning inserts



Type	Dimension(inch)			Grade								
	W ₀ ^{+0.004}	R±0.002	La _{max}	P		M			K			
				YBG202	YBG302	YBG202	YBG302	YD201	YBG302	YD201	YBG102	
Double edges												
ZTAD01502-MM	0.059±0.001	0.008	0.472	●	○	●	○			○		
ZTBD02002-MM	0.079±0.001	0.008	0.551	●	○	●	○			○		
ZTED02503-MM	0.098±0.001	0.012	0.670	●	○	●	○			○		
ZTFD0303-MM	0.118±0.001	0.012	0.670	●	○	●	○			○		
ZTGD0404-MM	0.157±0.002	0.016	0.866	●	○	●	○			○		
ZTHD0504-MM	0.197±0.002	0.016	0.866	●	○	●	○			○		
ZTKD0608-MM	0.236±0.002	0.031	0.866	●	○	●	○			○		
ZTLD0808-MM	0.315±0.002	0.031	1.102	●	○	●	○			○		

● Always stock available ○ Produce according to order

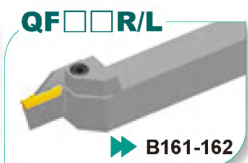
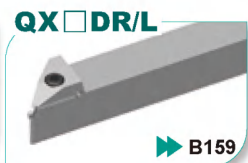
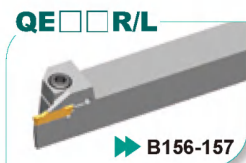

Applicable tool

Precision grooving and turning inserts

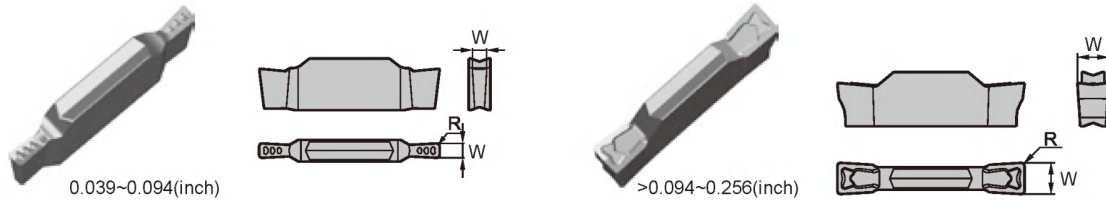

Type	Dimension(inch)			Grade								
	W ^{+0.004} ₀	R±0.002	L _a max	P		M			K			
				YBG202	YBG302	YBG202	YBG302	YD201	YBG302	YD201	YBG102	
Double cutting edges	ZTCD□□□□ ⁽¹⁾ -EG	0.039-0.094	Please see annotations (2)	0.670	○	○	○	○	○	○	○	○
	ZTED□□□□-EG	0.094-0.118		0.670	○	○	○	○	○	○	○	○
	ZTFD□□□□-EG	0.118-0.150		0.670	○	○	○	○	○	○	○	○
	ZTGD□□□□-EG	0.150-0.189		0.866	○	○	○	○	○	○	○	○
	ZTHD□□□□-EG	0.189-0.228		0.866	○	○	○	○	○	○	○	○
	ZTKD□□□□-EG	0.228-0.256		0.866	○	○	○	○	○	○	○	○

● Always stock available ○ Produce according to order

Note: (1)The code indicated with * is to be designated based on the edge width and edge radius. The code will be ZTFD03503-EG if the ordered inserts is with an edge width of 0.138inch and an edge radius of 0.118inch.

(2)Edge radius R is based on customers'requiremen.

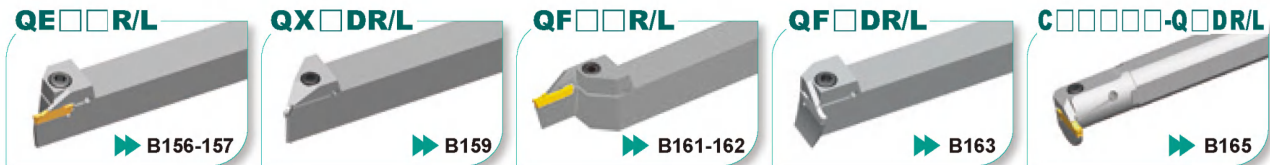

Applicable tool

Single-head grooving and turning inserts for semi-finishing to roughing in difficult-to-machine materials

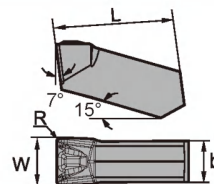

Type	Dimension(inch)				Grade			
	W±0.002	R±0.004	b	L	S			
					YBG105	YBG212	YBS103	YD101
ZIMF304N-SM	0.118	0.016	0.094	0.602	●	●	○	○
ZIMF404N-SM	0.157	0.016	0.126	0.602	●	●	○	○
ZIMF504N-SM	0.197	0.016	0.157	0.602	●	●	○	○
ZIMF604N-SM	0.236	0.016	0.201	0.602	●	●	○	○

● Always stock available ○ Produce according to order

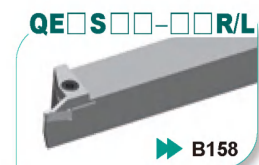

Applicable tool

B151○

Precision grooving and turning inserts

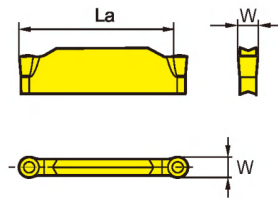

Type	Dimension(inch)			Grade								
	$W_{0}^{+0.004}$	R±0.002	La _{max}	P		M			K			
				YBG202	YBG302	YBG202	YBG302	YD201	YBG302	YD201	YBG102	
Double cutting edges												
ZRED025-MG	0.098	0.049	0.787	●	●	●	●		●			
ZRFD03-MG	0.118	0.059	0.787	●	●	●	●		●			
ZRGD04-MG	0.157	0.079	0.984	●	●	●	●		●			
ZRHD05-MG	0.197	0.098	0.984	○	●	○	●		●			
ZRKD06-MG	0.236	0.118	0.984	●	●	●	●		●			

● Always stock available ○ Produce according to order

Profile turning inserts for difficult-to-machine materials

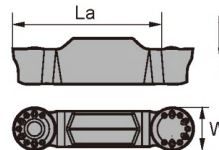

Type	Dimension(inch)		Grade		
	$W_{0}^{+0.004}$	La _{max}	S		
			YBG105	YBG212	YBS103
Double edge					
ZRFD03-NM	0.118	0.669	●	●	○
ZRGD04-NM	0.157	0.827	●	●	○
ZRHD05-NM	0.197	0.787	●	●	○
ZRKD06-NM	0.236	0.748	●	●	○

● Always stock available ○ Produce according to order

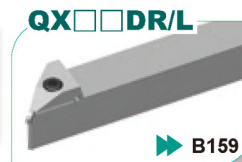

Applicable tool

Precision grooving and turning inserts

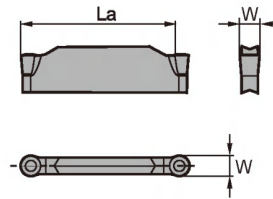

Type	Dimension(inch)			Grade							
	W±0.001	R±0.002	La _{max}	P		M			K		
				YBG202	YBG302	YBG202	YBG302	YD201	YBG302	YD201	YBG102
Double cutting edges	ZRFD03-EG	0.118	0.059	0.787		○		○	○	○	
	ZRGD04-EG	0.157	0.079	0.984		○		○	○		
	ZRHD05-EG	0.197	0.098	0.984		○		○	○		
	ZRKD06-EG	0.236	0.118	0.984		○		○	○		

● Always stock available ○ Produce according to order

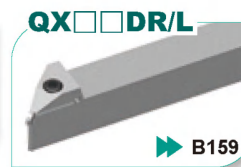
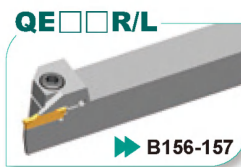

Applicable tool

Single-head grooving and turning inserts for precision profiling in difficult-to-machine materials

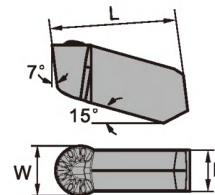

Type	Dimension(inch)			Grade			
	W±0.001	b	L	S			
				YBG102	YBG202	YBS103	YD101
ZIGQ3N-NM	0.118	0.094	0.602	●	○	●	○
ZIGQ4N-NM	0.157	0.126	0.602	●	○	●	○
ZIGQ5N-NM	0.197	0.157	0.602	●	○	○	○
ZIGQ6N-NM	0.236	0.201	0.602	●	○	○	○

● Always stock available ○ Produce according to order

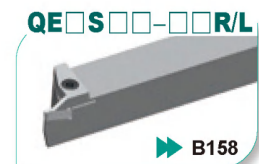

Applicable tool

Single-head grooving and turning inserts for precision profiling in difficult-to-machine materials

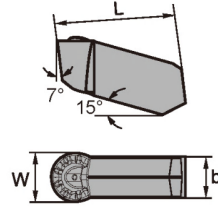

Type	Dimension(inch)			Grade		
	W±0.001	b	L	S		
				YBG105	YBG212	YBS103
ZIGQ3N-NF	0.118	0.094	0.602	●	●	○
ZIGQ4N-NF	0.157	0.126	0.602	●	●	○
ZIGQ5N-NF	0.197	0.157	0.602	●	●	○
ZIGQ6N-NF	0.236	0.200	0.602	●	●	○

● Always stock available ○ Produce according to order

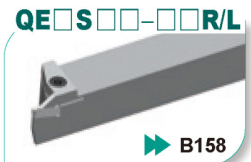

Applicable tool

External and face cutting tools code key

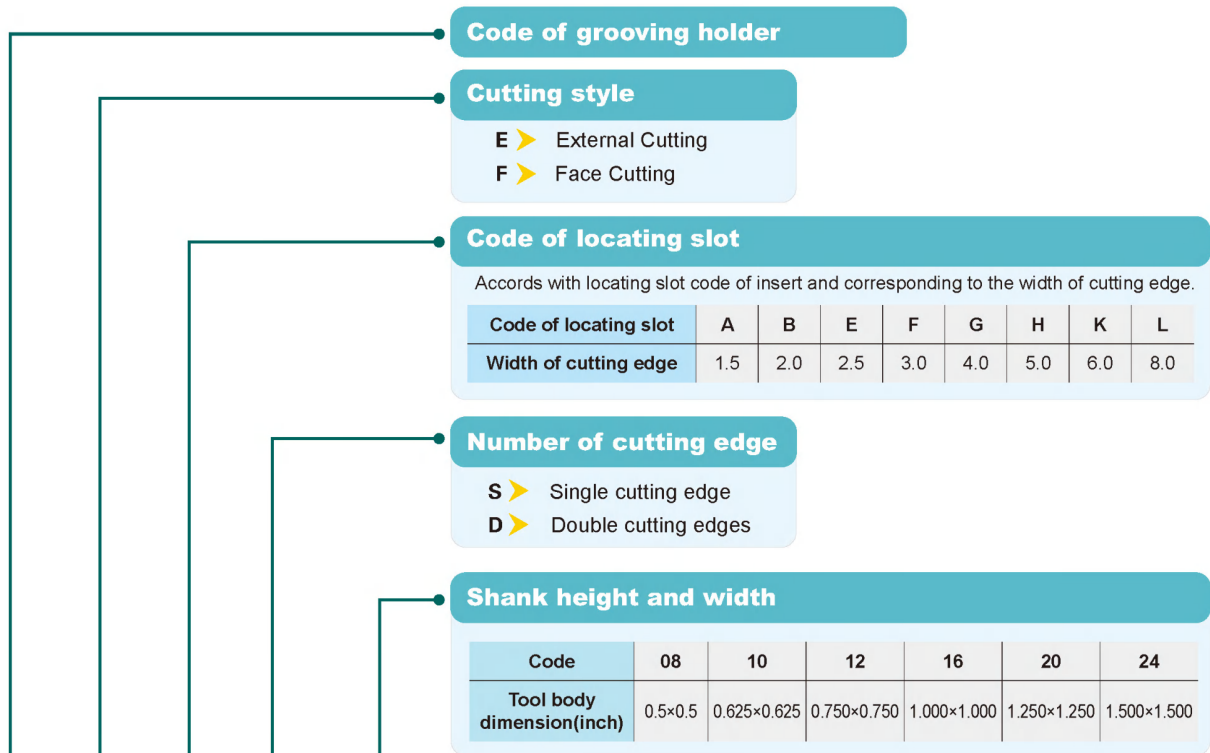

B

Q E G D 12 - 04 C R 22

Q F G D 16 - 04 D R 22 - 64 H

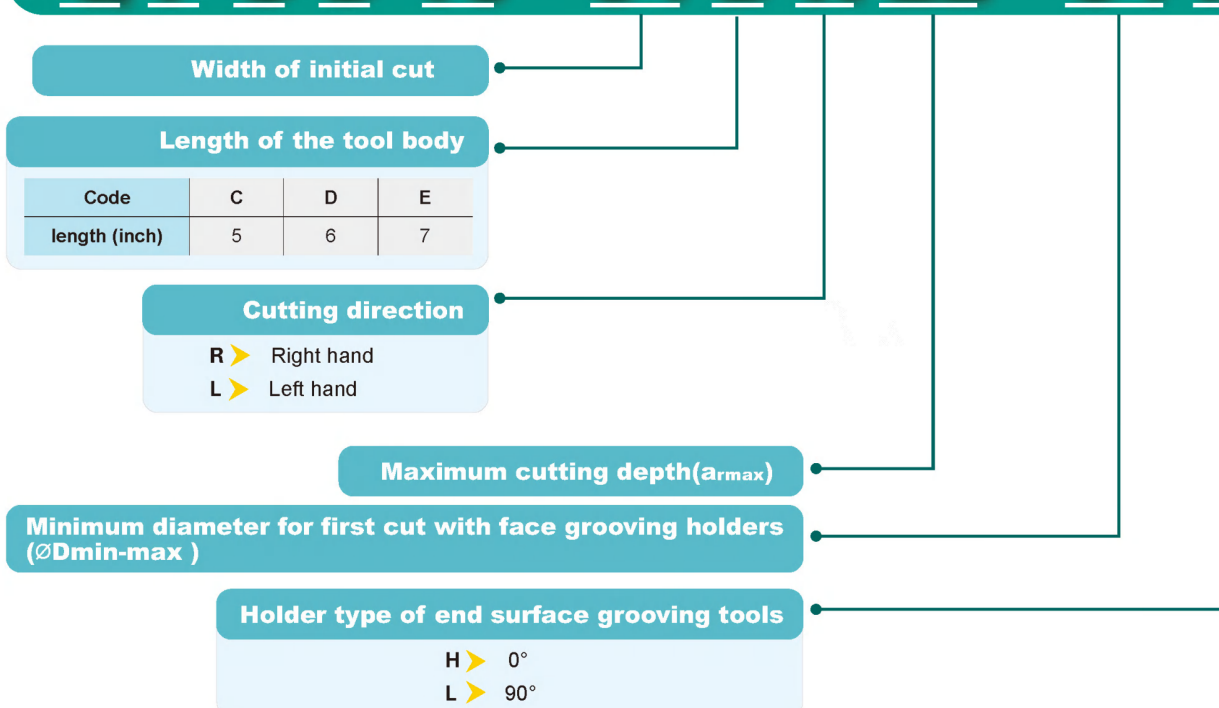

External parting, grooving and turning tools

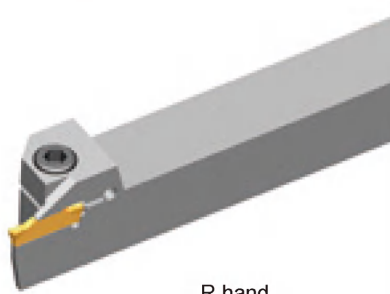

R hand

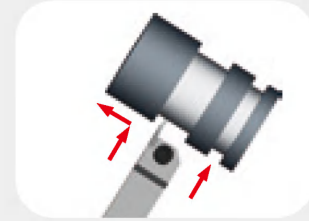
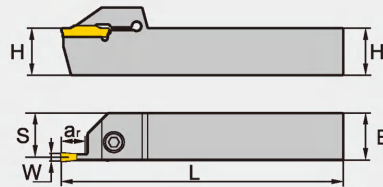

Type		Dimension(inch)					Applicable inserts	Screw	Wrench
		H×B	L	S	W	a _{rmax}			
QEAD	08-015CR/L07	0.500×0.500	5	0.478	0.059	0.276	Z□AD015□□	GB70-85-M5×16	WH40L
	08-015CR/L12	0.500×0.500	5	0.478	0.059	0.472	Z□AD015□□		
	10-015CR/L07	0.625×0.625	5	0.636	0.059	0.276	Z□AD015□□		
	10-015CR/L12	0.625×0.625	5	0.636	0.059	0.472	Z□AD015□□		
	12-015CR/L07	0.750×0.750	5	0.793	0.059	0.276	Z□AD015□□		
	12-015CR/L12	0.750×0.750	5	0.793	0.059	0.472	Z□AD015□□		
QEBD	08-02CR/L07	0.500×0.500	5	0.479	0.079	0.276	Z□BD02□□	GB70-85-M5×16	WH40L
	08-02CR/L10	0.500×0.500	5	0.479	0.079	0.394	Z□BD02□□		
	08-02CR/L14	0.500×0.500	5	0.479	0.079	0.551	Z□BD02□□		
	10-02CR/L07	0.625×0.625	5	0.636	0.079	0.276	Z□BD02□□		
	10-02CR/L10	0.625×0.625	5	0.636	0.079	0.394	Z□BD02□□		
	10-02CR/L14	0.625×0.625	5	0.636	0.079	0.551	Z□BD02□□		
	12-02CR/L07	0.750×0.750	5	0.794	0.079	0.276	Z□BD02□□		
	12-02CR/L10	0.750×0.750	5	0.794	0.079	0.394	Z□BD02□□		
	12-02CR/L14	0.750×0.750	5	0.794	0.079	0.551	Z□BD02□□		
	16-02DR/L07	1.000×1.000	6	0.991	0.079	0.276	Z□BD02□□	GB70-85-M6×20	WH50L
	16-02DR/L10	1.000×1.000	6	0.991	0.079	0.394	Z□BD02□□		
	16-02DR/L14	1.000×1.000	6	0.991	0.079	0.551	Z□BD02□□		
QEED	10-025CR/L10	0.625×0.625	5	0.591	0.098	0.394	Z□ED025□□	GB70-85-M5×20	WH40L
	10-025CR/L17	0.625×0.625	5	0.591	0.098	0.669	Z□ED025□□		
	12-025CR/L10	0.750×0.750	5	0.748	0.098	0.394	Z□ED025□□	GB70-85-M6×20	WH50L
	12-025CR/L17	0.750×0.750	5	0.748	0.098	0.669	Z□ED025□□		
	16-025DR/L10	1.000×1.000	6	0.945	0.098	0.394	Z□ED025□□		
	16-025DR/L17	1.000×1.000	6	0.945	0.098	0.669	Z□ED025□□		
QEFD	10-03CR/L10	0.625×0.625	5	0.583	0.118	0.394	Z□FD03□□	GB70-85-M5×20	WH40L
	10-03CR/L17	0.625×0.625	5	0.583	0.118	0.669	Z□FD03□□		
	12-03CR/L10	0.750×0.750	5	0.740	0.118	0.394	Z□FD03□□	GB70-85-M6×20	WH50L
	12-03CR/L17	0.750×0.750	5	0.740	0.118	0.669	Z□FD03□□		
	16-03DR/L10	1.000×1.000	6	0.937	0.118	0.394	Z□FD03□□		
	16-03DR/L17	1.000×1.000	6	0.937	0.118	0.669	Z□FD03□□		
QEGD	12-04CR/L13	0.750×0.750	5	0.728	0.157	0.512	Z□GD04□□	GB70-85-M6×20	WH50L
	12-04CR/L22	0.750×0.750	5	0.728	0.157	0.866	Z□GD04□□		
	16-04DR/L13	1.000×1.000	6	0.925	0.157	0.512	Z□GD04□□		

© Parting, grooving, turning, profiling inserts are adaptable to the tools

External parting, grooving and turning tools

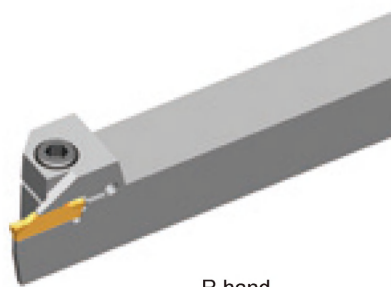

R hand

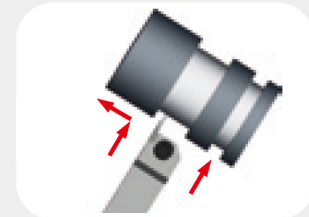
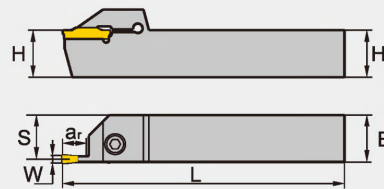

Type		Dimension(inch)					Applicable inserts	Screw	Wrench
		H×B	L	S	W	a _{rmax}			
QEGD	16-04DR/L22	1.000×1.000	6	0.925	0.157	0.866	Z□GD04□□	GB70-85-M6×20	WH50L
	20-04ER/L13	1.250×1.250	7	1.201	0.157	0.512	Z□GD04□□		
	20-04ER/L22	1.250×1.250	7	1.201	0.157	0.866	Z□GD04□□		
QEHD	16-05DR/L13	1.000×1.000	6	0.906	0.197	0.512	Z□HD05□□	GB70-85-M6×20	WH50L
	16-05DR/L22	1.000×1.000	6	0.906	0.197	0.866	Z□HD05□□		
QEHS	16-05DN30	1.000×1.000	6	0.492	0.197	1.181	Z□HS05□□		
QEHD	20-05ER/L13	1.250×1.250	7	1.181	0.197	0.512	Z□HD05□□		
	20-05ER/L22	1.250×1.250	7	1.181	0.197	0.866	Z□HD05□□		
QEHS	20-05EN30	1.250×1.250	7	0.630	0.197	1.181	Z□HS05□□		
QEKD	16-06DR/L13	1.000×1.000	6	0.890	0.236	0.512	Z□KD06□□	GB70-85-M6×20	WH50L
	16-06DR/L22	1.000×1.000	6	0.890	0.236	0.866	Z□KD06□□		
QEKS	16-06DN30	1.000×1.000	6	0.492	0.236	1.181	Z□KS06□□		
QEKD	20-06ER/L13	1.250×1.250	7	1.165	0.236	0.512	Z□KD06□□		
	20-06ER/L22	1.250×1.250	7	1.165	0.236	0.866	Z□KD06□□		
QEKS	20-06EN30	1.250×1.250	7	0.630	0.236	1.181	Z□KS06□□		
QELD	16-08DR/L16	1.000×1.000	6	0.886	0.315	0.630	ZTLD0808-MM	GB70-85-M6×20	WH50L
	16-08DR/L25	1.000×1.000	6	0.886	0.315	0.984	ZTLD0808-MM		
	20-08ER/L28	1.250×1.250	7	1.142	0.315	1.102	ZTLD0808-MM		

© Parting, grooving, turning, profiling inserts are adaptable to the tools

External parting, grooving and turning tools

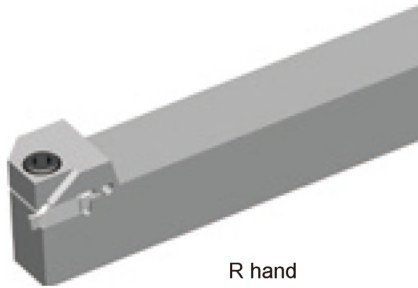

R hand

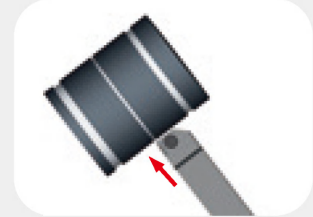
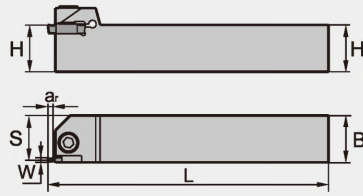

Type	Dimension(inch)					Applicable inserts	Screw	Wrench
	H×B	L	S	W	a _{max}			
QECD	10-XCR/L025	0.625×0.625	5	0.581	0.039~0.256 (Made to order)	ZTCD□□□□□-EG	GB70-85-M5×20	WH40L
	12-XCR/L025	0.750×0.750	5	0.738				
	16-XCR/L025	1.000×1.000	6	0.935				

External grooving tools for materials hard to be machined

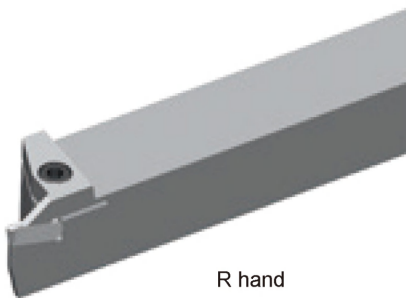



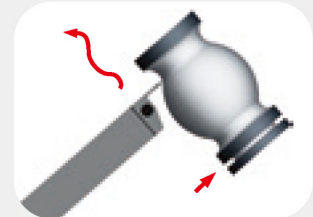
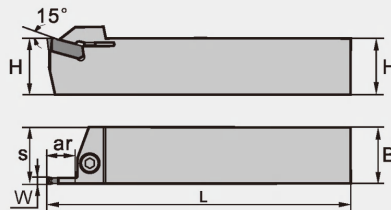



R hand

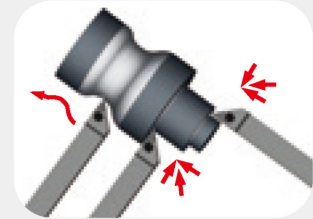
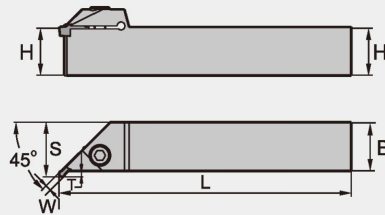
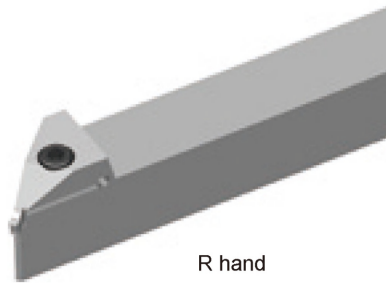

Type	Dimension(inch)					Applicable inserts	Screw	Wrench
	H×B	L	S	W	a _{max}			
QEFS16-03DR/L12	1.000×1.000	6	1.000	0.118	0.472	ZIGQ3N-□□ ZIMF304N-□□	GB70-85-M6×20	WH50L
QEGS16-04DR/L12	1.000×1.000	6	1.000	0.157	0.472	ZIGQ4N-□□ ZIMF40□N-□□		
QEHS16-05DR/L12	1.000×1.000	6	1.000	0.197	0.472	ZIGQ5N-□□ ZIMF50□N-□□		
QEKs16-06DR/L12	1.000×1.000	6	1.000	0.236	0.472	ZIGQ6N-□□ ZIMF60□N-□□		

Precision grooving and turning tools



Type		Dimension(inch)					Applicable inserts	Screw	Wrench
		H×B	L	S	W	α _{max}			
QXFD	12-03CR/L03	0.750×0.750	5	0.906	0.118	0.118	 ZR(T)FD03-EG ZR(T)FD03-MG	GB70-85-M6×20	 WH50L
	16-03DR/L03	1.000×1.000	6	1.102					
	20-03ER/L03	1.250×1.250	7	1.378					
QXGD	12-04CR/L03	0.750×0.750	5	0.906	0.157	0.118	 ZR(T)GD04-EG ZR(T)GD04-MG		
	16-04DR/L03	1.000×1.000	6	1.102					
	20-04ER/L03	1.250×1.250	7	1.378					
QXHD	12-05CR/L04	0.750×0.750	5	0.945	0.197	0.157	 ZR(T)HD05-EG ZR(T)HD05-MG		
	16-05DR/L04	1.000×1.000	6	1.142					
	20-05ER/L04	1.250×1.250	7	1.417					
QXKD	12-06CR/L04	0.750×0.750	5	0.945	0.236	0.157	 ZR(T)KD06-EG ZR(T)KD06-MG		
	16-06DR/L04	1.000×1.000	6	1.142					
	20-06ER/L04	1.250×1.250	7	1.417					

Parting blade holder code key

Code of parting blade holder

Number of cutting edge

- S > Single cutting edge
- D > Double cutting edges

Size of holders

code of holders	0750	1000	1250
Size of holders (inch)	0.750	1.000	1.250

Height of blade

QZ S 1250 32

Parting Blade Holders

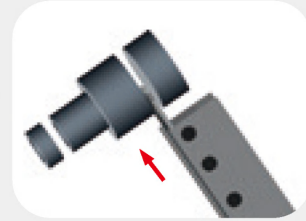
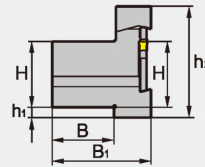

Type	Dimension(inch)						Clamps	Screw	Wrench
	L	H	h ₁	h ₂	B	B ₁			
QZS0750-26	3.386	0.750	0.394	1.835	0.748	1.496	QZC26	GB70-85-M6×20	WH50L
QZS1000-26	3.386	1.000	0.197	1.835	0.906	1.654	QZC26		
QZS1250-26	3.386	1.250	0.118	2.031	1.181	1.890	QZC26		
QZS0750-32	4.331	0.750	0.512	1.969	0.748	1.496	QZC32		
QZS1000-32	4.331	1.000	0.315	1.969	0.906	1.654	QZC32		
QZS1250-32	4.331	1.250	0.197	2.126	1.181	1.890	QZC32		

External Parting Blade

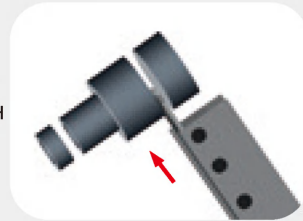
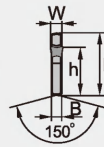
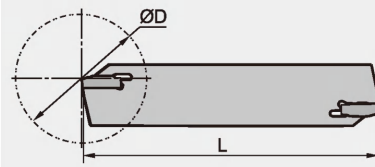
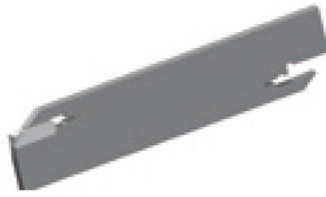

Type	Dimension(inch)						Inserts	Wrench
	L	H	h	B	W	ØDmax		
QEES26N	4.331	1.024	0.748	0.079	0.098	2.362	ZPES02502-MG	W50RL
QEFS26N	4.331	1.024	0.748	0.094	0.118	2.362	ZPFS0302-MG	
QEGS26N	4.331	1.024	0.748	0.126	0.157	2.756	ZPGS0402-MG	
QEHS26N	4.331	1.024	0.748	0.157	0.197	2.756	ZPHS0503-MG	
QEKs26N	4.331	1.024	0.748	0.197	0.236	2.756	ZPKS0604-MG	
QEES32N	5.906	1.260	0.969	0.079	0.098	3.937	ZPES02502-MG	
QEFS32N	5.906	1.260	0.969	0.094	0.118	3.937	ZPFS0302-MG	
QEGS32N	5.906	1.260	0.969	0.126	0.157	4.724	ZPGS0402-MG	
QEHS32N	5.906	1.260	0.969	0.157	0.197	4.724	ZPHS0503-MG	
QEKs32N	5.906	1.260	0.969	0.197	0.236	4.724	ZPKS0604-MG	

Face Grooving and Turning Tools

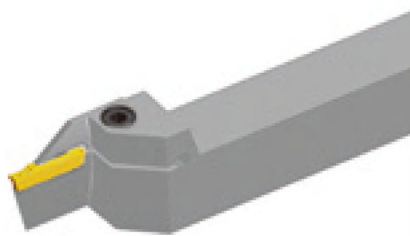

L hand

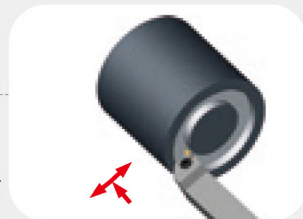
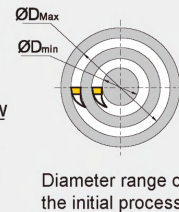
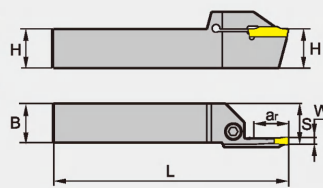

Type	Dimension(inch)						Inserts	Screw	Wrench
	HxB	L	S	W	ar	ØD (min-max)			
QFFD16-03DR/L10-48H	1.000×1.000	6	1.024	0.118	0.394	1.890-2.598	ZTFD0303-MG	GB70-85-M6×20	WH50L
QFFD16-03DR/L17-48H	1.000×1.000	6	1.024	0.118	0.669	1.890-2.598			
QFFD16-03DR/L10-60H	1.000×1.000	6	1.024	0.118	0.394	2.362-3.150			
QFFD16-03DR/L17-60H	1.000×1.000	6	1.024	0.118	0.669	2.362-3.150			
QFFD16-03DR/L10-74H	1.000×1.000	6	1.024	0.118	0.394	2.913-4.331			
QFFD16-03DR/L17-74H	1.000×1.000	6	1.024	0.118	0.669	2.913-4.331			

Face Grooving and Turning Tools

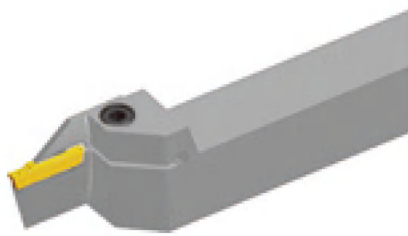

L hand

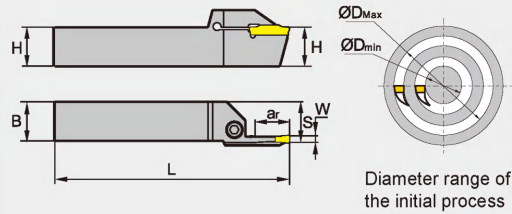

Type	Dimension(inch)						Inserts	Screw	Wrench
	HxB	L	S	W	ar	ØD (min-max)			
QFFD16-03DR/L10-100H	1.000×1.000	6	1.024	0.118	0.394	3.937-5.906	ZTFD0303-MG	GB70-85-M6×20	WH50L
QFFD16-03DR/L17-100H	1.000×1.000	6	1.024	0.118	0.669	3.937-5.906			
QFGD16-04DR/L13-52H	1.000×1.000	6	1.024	0.157	0.512	2.047-2.835	ZTGD0404-MG		
QFGD16-04DR/L22-52H	1.000×1.000	6	1.024	0.157	0.866	2.047-2.835			
QFGD16-04DR/L13-64H	1.000×1.000	6	1.024	0.157	0.512	2.520-3.937			
QFGD16-04DR/L22-64H	1.000×1.000	6	1.024	0.157	0.866	2.520-3.937			
QFGD16-04DR/L13-90H	1.000×1.000	6	1.024	0.157	0.512	3.543-5.512			
QFGD16-04DR/L22-90H	1.000×1.000	6	1.024	0.157	0.866	3.543-5.512			
QFGD16-04DR/L13-130H	1.000×1.000	6	1.024	0.157	0.512	5.118-9.055			
QFGD16-04DR/L22-130H	1.000×1.000	6	1.024	0.157	0.866	5.118-9.055			
QFHD16-05DR/L13-58H	1.000×1.000	6	1.024	0.197	0.512	2.238-3.780			
QFHD16-05DR/L22-58H	1.000×1.000	6	1.024	0.197	0.866	2.238-3.780			
QFHD16-05DR/L13-86H	1.000×1.000	6	1.024	0.197	0.512	3.386-5.512			
QFHD16-05DR/L22-86H	1.000×1.000	6	1.024	0.197	0.866	3.386-5.512			
QFHD16-05DR/L13-130H	1.000×1.000	6	1.024	0.197	0.512	5.118-7.874			
QFHD16-05DR/L22-130H	1.000×1.000	6	1.024	0.197	0.866	5.118-7.874			
QFHD16-05DR/L13-185H	1.000×1.000	6	1.024	0.197	0.512	7.283-15.748	ZTHS0504-MG		
QFHD16-05DR/L22-185H	1.000×1.000	6	1.024	0.197	0.866	7.283-15.748			
QFHS16-05DR/L30-185H	1.000×1.000	6	1.024	0.197	1.181	7.283-15.748			
QFKD16-06DR/L13-60H	1.000×1.000	6	1.024	0.236	0.512	2.362-3.937	ZTKD0608-MG		
QFKD16-06DR/L22-60H	1.000×1.000	6	1.024	0.236	0.866	2.362-3.937			
QFKD16-06DR/L13-88H	1.000×1.000	6	1.024	0.236	0.512	3.465-7.087			
QFKD16-06DR/L22-88H	1.000×1.000	6	1.024	0.236	0.866	3.465-7.087			
QFKD16-06DR/L13-160H	1.000×1.000	6	1.024	0.236	0.512	6.299-15.748			
QFKD16-06DR/L22-160H	1.000×1.000	6	1.024	0.236	0.866	6.299-15.748			
QFKS16-06DR/L30-160H	1.000×1.000	6	1.024	0.236	1.181	6.299-15.748	ZTKS0608-MG		
QFLD16-08DR/L25-75H	1.000×1.000	6	1.063	0.315	0.984	2.953-5.906	ZTLD0808-MM		
QFLD16-08DR/L25-140H	1.000×1.000	6	1.063	0.315	0.984	5.512-15.748			
QFLD20-08ER/L28-140H	1.250×1.250	7	1.181	0.315	1.102	5.512-15.748			
								GB70-85-M8×30	WH60L

Face Grooving and Turning Tools

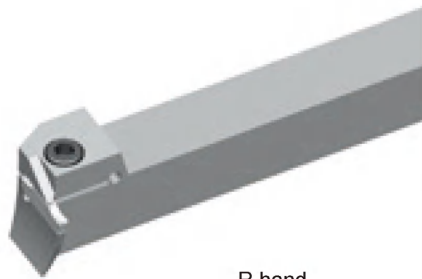

R hand

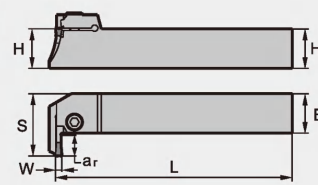

Diameter range of the initial process



Type	Dimension(inch)						Inserts	Screw	Wrench
	H×B	L	S	W	ar	ØD (min-max)			
QFFD16-03DR/L10-48L	1.000×1.000	6	1.024	0.118	0.394	1.890-2.598	ZTFD0303-MG	GB70-85-M6×20	WH50L
QFFD16-03DR/L17-48L	1.000×1.000	6	1.024	0.118	0.669	1.890-2.598			
QFFD16-03DR/L10-60L	1.000×1.000	6	1.024	0.118	0.394	2.362-3.150			
QFFD16-03DR/L17-60L	1.000×1.000	6	1.024	0.118	0.669	2.362-3.150			
QFFD16-03DR/L10-74L	1.000×1.000	6	1.024	0.118	0.394	2.913-4.331			
QFFD16-03DR/L17-74L	1.000×1.000	6	1.024	0.118	0.669	2.913-4.331			
QFFD16-03DR/L10-100L	1.000×1.000	6	1.024	0.118	0.394	3.937-5.906			
QFFD16-03DR/L17-100L	1.000×1.000	6	1.024	0.118	0.669	3.937-5.906			
QFGD16-04DR/L13-52L	1.000×1.000	6	1.024	0.157	0.512	2.047-2.835	ZTGD0404-MG		
QFGD16-04DR/L22-52L	1.000×1.000	6	1.024	0.157	0.866	2.047-2.835			
QFGD16-04DR/L13-64L	1.000×1.000	6	1.024	0.157	0.512	2.520-3.937			
QFGD16-04DR/L22-64L	1.000×1.000	6	1.024	0.157	0.866	2.520-3.937			
QFGD16-04DR/L13-90L	1.000×1.000	6	1.024	0.157	0.512	3.543-5.512			
QFGD16-04DR/L22-90L	1.000×1.000	6	1.024	0.157	0.866	3.543-5.512			
QFGD16-04DR/L13-130L	1.000×1.000	6	1.024	0.157	0.512	5.118-9.055			
QFGD16-04DR/L22-130L	1.000×1.000	6	1.024	0.157	0.866	5.118-9.055			
QFHD16-05DR/L13-58L	1.000×1.000	6	1.024	0.197	0.512	2.238-3.780	ZTHD0504-MG		
QFHD16-05DR/L22-58L	1.000×1.000	6	1.024	0.197	0.866	2.238-3.780			
QFHD16-05DR/L13-86L	1.000×1.000	6	1.024	0.197	0.512	3.386-5.512			
QFHD16-05DR/L22-86L	1.000×1.000	6	1.024	0.197	0.866	3.386-5.512			
QFHD16-05DR/L13-130L	1.000×1.000	6	1.024	0.197	0.512	5.118-7.874			
QFHD16-05DR/L22-130L	1.000×1.000	6	1.024	0.197	0.866	5.118-7.874			
QFHD16-05DR/L13-185L	1.000×1.000	6	1.024	0.197	0.512	7.283-15.748			
QFHD16-05DR/L22-185L	1.000×1.000	6	1.024	0.197	0.866	7.283-15.748			
QFHS16-05DR/L30-185L	1.000×1.000	6	1.024	0.197	1.181	7.283-15.748	ZTHS0504-MG		
QFKD16-06DR/L13-60L	1.000×1.000	6	1.024	0.236	0.512	2.362-3.937	ZTKD0608-MG		
QFKD16-06DR/L22-60L	1.000×1.000	6	1.024	0.236	0.866	2.362-3.937			
QFKD16-06DR/L13-88L	1.000×1.000	6	1.024	0.236	0.512	3.465-7.087			
QFKD16-06DR/L22-88L	1.000×1.000	6	1.024	0.236	0.866	3.465-7.087			
QFKD16-06DR/L13-160L	1.000×1.000	6	1.024	0.236	0.512	6.299-15.748			
QFKD16-06DR/L22-160L	1.000×1.000	6	1.024	0.236	0.866	6.299-15.748			
QFKS16-06DR/L30-160L	1.000×1.000	6	1.024	0.236	1.181	6.299-15.748	ZTKS0608-MG		

B

Internal cutting tools code key

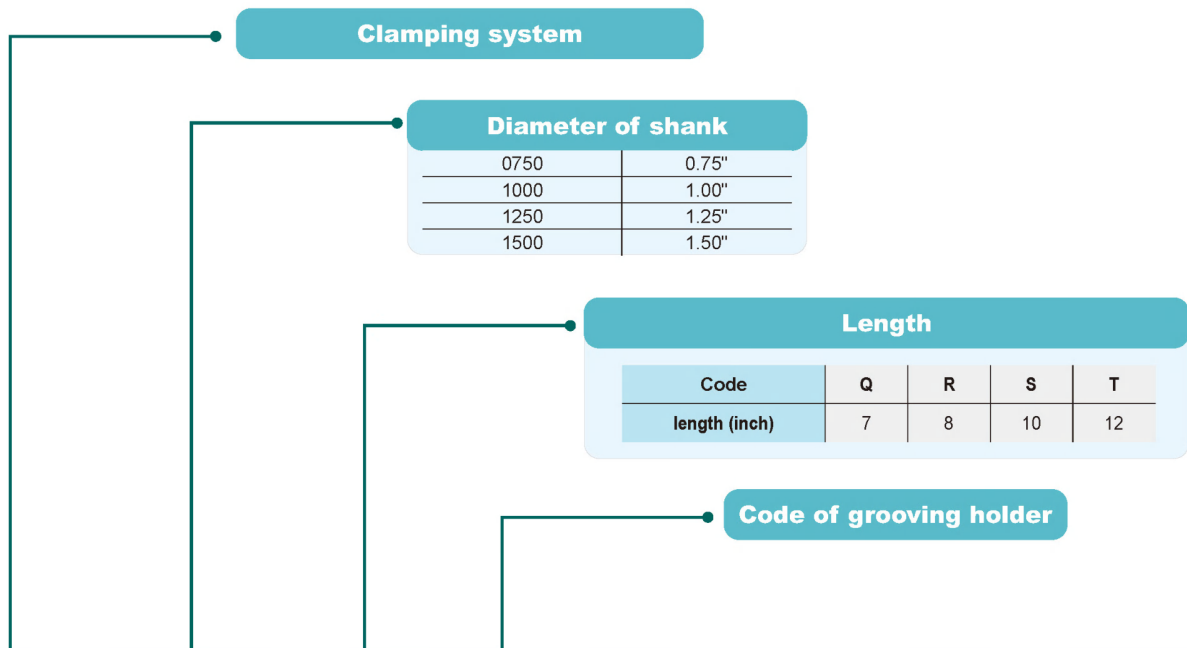

C 1250 S - Q G D R 11 14

Code of locating slot

Accords with locating slot code of insert and corresponding to the width of cutting edge.

Code of locating slot	E	F	G	H	K
Width of cutting edge(inch)	0.098	0.118	0.157	0.197	0.236

Number of cutting edge

- S > Single cutting edge
- D > Double cutting edges

Cutting direction

- R > Right hand
- L > Left hand

Maximum cutting depth(a_{max})

Minimum machining diameter($\varnothing D$)

Internal grooving and turning tools

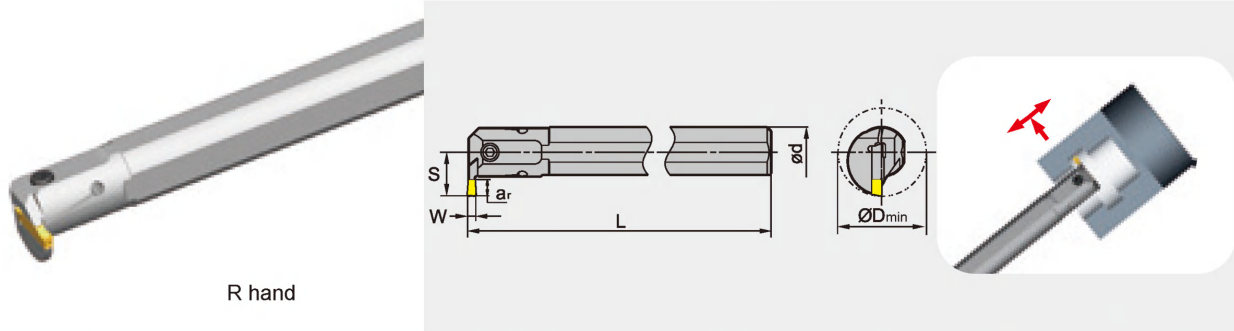

Type	Dimension(inch)						Applicable inserts	Screw	Wrench
	ød	L	S	W	ar _{max}	ØD			
C0750Q-QEDR/L05-27	0.750	7	0.598	0.098	0.197	1.063	ZTED025-□□ ZRED□□□□□-□□	GB70-85-M4×12	WH30L
C1000R-QEDR/L07-33	1.000	8	0.799	0.098	0.276	1.299		GB70-85-M5×16	WH40L
C1250S-QEDR/L09-42	1.250	10	0.996	0.098	0.354	1.654		GB70-85-M5×20	
C0750Q-QFDR/L05-27	0.750	7	0.598	0.118	0.197	1.063	ZTFD□□□□□-□□ ZRFD□□□□□-□□	GB70-85-M4×12	WH30L
C1000R-QFDR/L07-33	1.000	8	0.799	0.118	0.276	1.299		GB70-85-M5×16	WH40L
C1250S-QFDR/L09-42	1.250	10	0.966	0.118	0.354	1.654		GB70-85-M5×20	
C1000R-QGDR/L08-35	1.000	8	0.846	0.157	0.315	1.378	ZTGD□□□□□-□□ ZRGD□□□□□-□□	GB70-85-M5×16	WH40L
C1250S-QGDR/L11-44	1.250	10	1.083	0.157	0.433	1.732		GB70-85-M6×20	WH50L
C1500T-QGDR/L13-54	1.500	12	1.319	0.157	0.512	2.216		GB70-85-M6×20	
C1000R-QHDR/L08-35	1.000	8	0.846	0.197	0.315	1.378	ZTHD□□□□□-□□ ZRHd□□□□□-□□	GB70-85-M5×16	WH40L
C1250S-QHDR/L11-44	1.250	10	1.083	0.197	0.433	1.732		GB70-85-M6×20	WH50L
C1500T-QHDR/L13-54	1.500	12	1.319	0.197	0.512	2.126		GB70-85-M6×20	
C1000R-QKDR/L08-35	1.000	8	0.846	0.236	0.315	1.378	ZTKD□□□□□-□□ ZRKD□□□□□-□□	GB70-85-M5×16	WH40L
C1250S-QKDR/L11-44	1.250	10	1.083	0.236	0.433	1.732		GB70-85-M6×20	WH50L
C1500T-QKDR/L13-54	1.500	12	1.319	0.236	0.512	2.126		GB70-85-M6×20	

B

● Recommended cutting parameters for parting and grooving tools

Insert size	Recommended feed rate(inch/r)			
	Parting	Grooving	Turning	Profiling
Insert width(inch)				
0.098	0.002-0.006	0.002-0.006	0.002-0.006	0.002-0.006
0.118	0.002-0.006	0.002-0.006	0.003-0.006	0.004-0.008
0.157	0.002-0.008	0.002-0.008	0.003-0.010	0.004-0.008
0.197	0.003-0.008	0.003-0.009	0.004-0.010	0.006-0.012
0.236	0.004-0.012	0.003-0.010	0.004-0.012	0.006-0.012

Workpiece material	Hardness	YBG302	YBG202 YBG205	YBG105	YBG212	YBC151	YBC251	YBS103	YD101	YD201	YBG102
P	Carbon steel	125≤HB≤170	100-850	500-1000		450-1000	500-900				
	Low alloy steel	180≤HB≤275	260-600	360-650		300-800	360-650				
	High alloy steel	180≤HB≤325	260-500	360-600		300-700	360-600				
	Cast steel	180≤HB≤250	240-450	300-550		260-500	300-550				
M	Ferrite, Martensite	200≤HB≤300	230-550	300-650			300-650				
	Austenite	180≤HB≤300	260-650	360-700			360-700				
K	Malleable cast iron	130≤HB≤230	300-650	400-700						300-500	
	Grey cast iron	180≤HB≤220	300-550	400-650						260-450	
	Nodular cast iron	160≤HB≤250	260-500	360-600						200-450	
N	Al alloy	--							650-1300		
S	High-temperature alloy	≤400			130-230	60-160		100-260	60-160		100-200

The cutting parameters recommended are suitable for wet machining.
Advice: internal machining and face machining, the cutting speed should be reduced by 30%-40%.

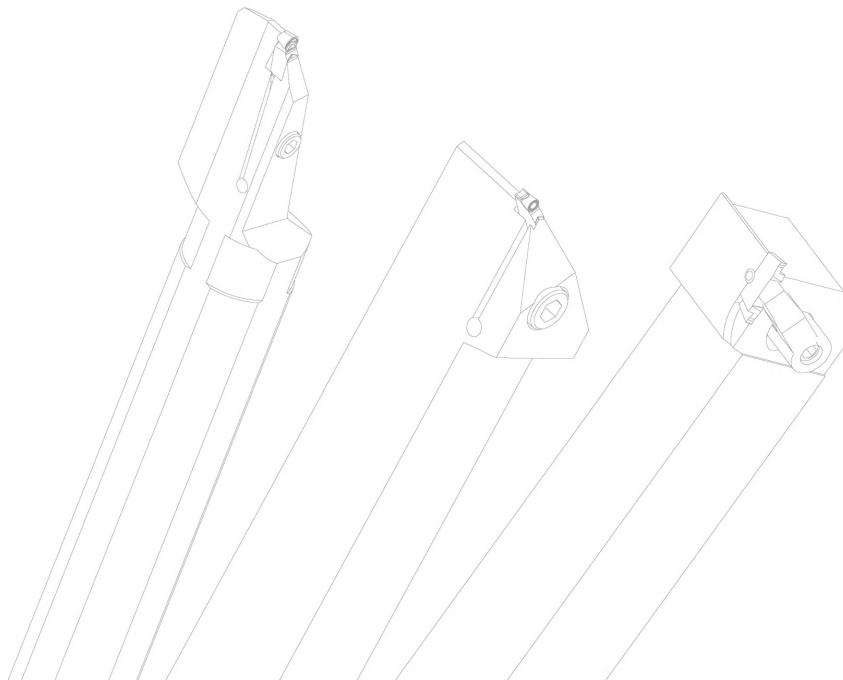

Centerline Parting and Grooving Tools

- No matter which parting or grooving tools are selected, the best performance is realized when insert is positioned at the centerline of workpiece. This also reduces vibrations during machining.
- The insert cutting edge and centerline of workpiece should be within $\pm .004$. For parting and grooving workpieces with small diameter, this especially true to reduce cutting force, reduce burring, and improve tool life.

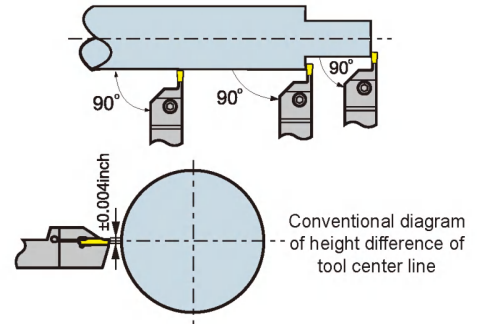

Parting

- When the insert is approaching center of workpiece, the cutting speed should be reduced by 30%, which is good for improving tool life and surface quality.
- Whenever possible, shorten the overhang of the tool as much as possible to ensure good stability.

External grooving, turning, and profiling

- In-Feed Sequence: When Cutting Depth > 0.020 ", Radial in-feed (Max. Cutting depth can be $3/4$ of the insert edge width) \rightarrow Radial out-feed about 0.004 " \rightarrow Axial in feed \rightarrow Flank out-feed \rightarrow Axial in feed \rightarrow Radial machining to required depth.
- When finishing, use sequence as shown in the diagram to reduce vibration.

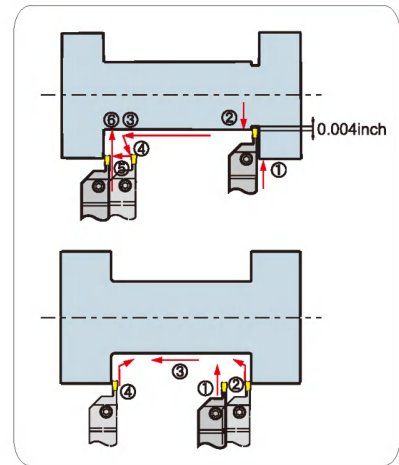

Face grooving and turning

- Finishing Machining (Multi-slot Cutting)
First cut inward from max diameter of face opening, then reposition insert, as shown in diagram (1).
- Face groove turning
Axial turning depth should not be more than $3/4$ of the cutting edge width.
When slot width is larger than slot depth, turn with multiple passes, as shown in the picture(2).
- Finishing Machining
First finish machine bottom and external diameter fringe, then finish the internal diameter to required size, as shown in the picture (3).

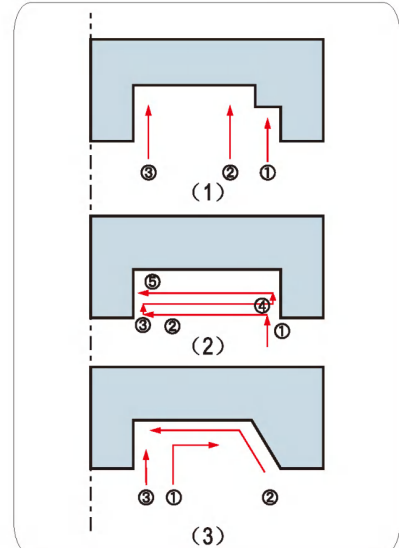

Internal grooving and turning

- For good chip flow, follow the machining sequence in the diagram shown. Infeed from the deepest end of the hole and then back turn.

