











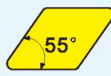

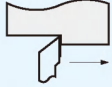

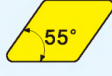

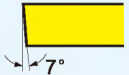



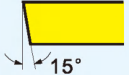

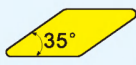

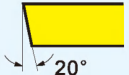
External turning toolholders code key

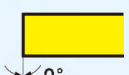
Insert mounting method	Insert shape		Insert clearance angle	Cutting direction
 D-Double clamping	 80°	 55°	 5°	 L-Left hand
 P-Lever Clamp	 55°	 R	 7°	
 M-Multi Clamp	 90°	 60°	 15°	 R-Right hand
 S-Screw Clamp	 35°	 80°	 20°	
 C-Top Clamp			 0°	 N-Neutral
			 11°	

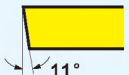
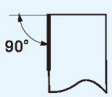
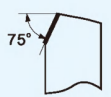
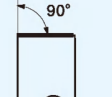
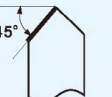
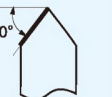
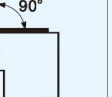
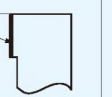
M C L N R

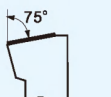
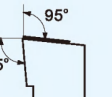
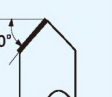
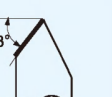
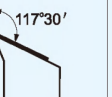
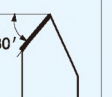
Tool holder style							
A	B	C	D	E	F	G	H
 90°	 75°	 90°	 45°	 60°	 90°	 90°	 107°30'
 93°	 75°	 95°	 50°	 63°	 117°30'	 62°30'	 107°30'
 75°	 45°	 60°	 93°	 72°30'	 60°	 120°	

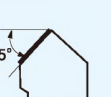
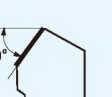
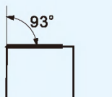
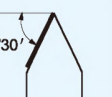
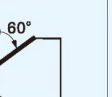
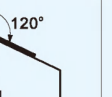
Tool holder height and width

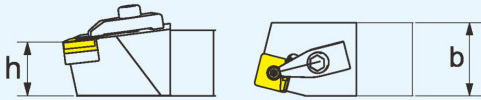

NO.	b	h	NO.	b	h
05	0.3125	0.3125	24	1.50	1.50
06	0.375	0.375	32	2.00	2.00
08	0.50	0.50	64	0.75	1.00
10	0.625	0.625	66	0.75	1.50
12	0.75	0.75	85	1.00	1.25
16	1.00	1.00	86	1.00	1.50
20	1.25	1.25	91	1.25	1.50

Insert I.C size

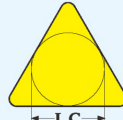

Number of 1/8" of inscribed circle

- 2 = 0.250"
- 3 = 0.375"
- 4 = 0.500"
- 5 = 0.625"
- 6 = 0.750"
- 7 = 0.875"
- 8 = 1.000"

Tool Length

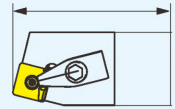

- A = 4"
- B = 4.5"
- C = 5"
- D = 6"
- E = 7"
- F = 8"
- *J=3.5"
- *K=2.75"
- *L=2.36"
- *ZCC•CT standard only

16 - 4 D







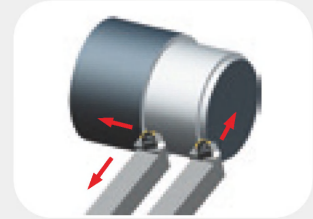
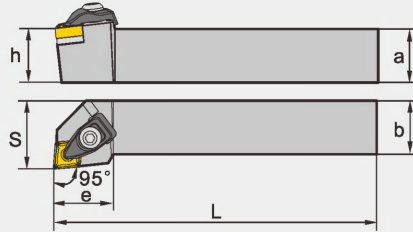
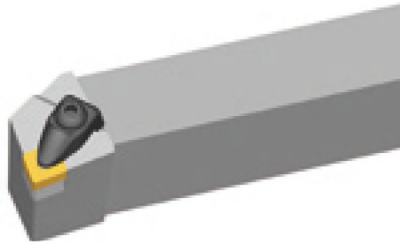

Applicable toolholders to **CN**□□

D-type clamping

DCLNR/L 95°



Type	Dimension(inch)						Applicable inserts  A30-35,A82-83	Clamping screw 	Shim 	Wrench 	Clamp 	Shim screw 	Spring 
	a	b	L	h	s	e							
DCLNR/L 10-3A	0.625	0.625	4.00	0.625	0.75	0.945							
DCLNR/L 12-3C	0.75	0.75	5.00	0.75	1.00	0.945	CN□□32□□	CM5×22C	C09BM	WH30L	C1RA	SM5×8.65XA1	SPR6
DCLNR/L 16-3D	1.00	1.00	6.00	1.00	1.25	0.945							
DCLNR/L 12-4C	0.75	0.75	5.00	0.75	1.00	1.102							
DCLNR/L 16-4D	1.00	1.00	6.00	1.00	1.25	1.102	CN□□43□□	CM6×25C	C12BM	WH40L	C2RA	SM6×10XA1	SPR4
DCLNR/L 85-4E	1.25	1.00	7.00	1.25	1.25	1.102							









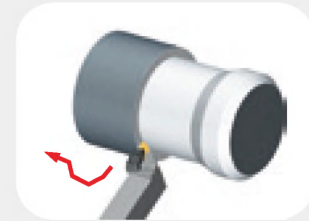
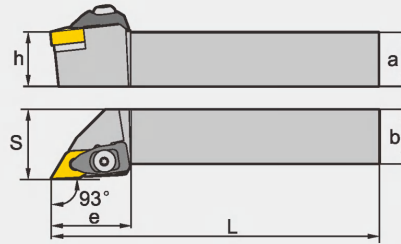

Applicable toolholders to **DN** □ □

D-type clamping

DDJNR/L

93°



Type	Dimension(inch)						Applicable inserts  A36-41, A84-86	Clamping screw 	Shim 	Wrench 	Clamp 	Shim screw 	Spring 
	a	b	L	h	s	e							
DDJNR/L 10-3A	0.625	0.625	4.00	0.625	0.75	1.180	DN □ □ 33 □ □	CM5×22C	D11BM	WH30L	C1RA	SM5×8.65XA1	SPR6
DDJNR/L 12-3C	0.75	0.75	5.00	0.75	1.00	1.180							
DDJNR/L 16-3D	1.00	1.00	6.00	1.00	1.25	1.180							
DDJNR/L 85-3E	1.25	1.00	7.00	1.25	1.25	1.180							
DDJNR/L 12-4C	0.75	0.75	5.00	0.75	1.00	1.378	DN □ □ 44 □ □	CM6×25C	D15BM	WH40L	C2RA	SM6×10XA1	SPR4
DDJNR/L 16-4D	1.00	1.00	6.00	1.00	1.25	1.378							
DDJNR/L 16-4D-3	1.00	1.00	6.00	1.00	1.25	1.378	DN □ □ 43 □ □	CM6×25C	D15BM	WH40L	C2RA	SM6×10XA1	SPR4
DDJNR/L 20-4E	1.25	1.25	7.00	1.25	1.57	1.378	DN □ □ 44 □ □						
DDJNR/L 20-4E-3	1.25	1.25	7.00	1.25	1.57	1.378	DN □ □ 43 □ □						





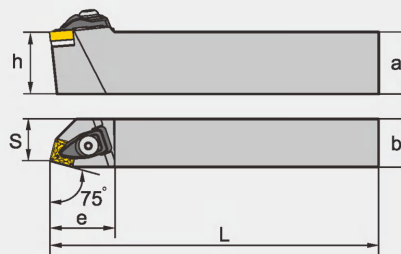

Applicable toolholders to **SN** □ □

D-type clamping

DSBNR/L

75°







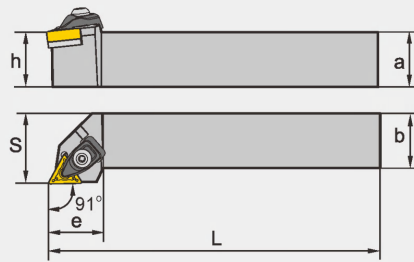

Type	Dimension(inch)						Applicable inserts  A42-47, A87-89	Clamping screw 	Shim 	Wrench 	Clamp 	Shim screw 	Spring 
	a	b	L	h	s	e							
DSBNR/L 10-3A	0.625	0.625	4.00	0.625	0.512	1.024	SN □ □ 32 □ □	CM5×22C	S09BM	WH30L	C1RA	SM5×8.65XA1	SPR6
DSBNR/L 12-4C	0.75	0.75	5.00	0.75	0.669	1.339							
DSBNR/L 16-4D	1.00	1.00	6.00	1.00	0.866	1.339	SN □ □ 43 □ □	CM6×25C	S12BM	WH40L	C2RA	SM6×10XA1	SPR4
DSBNR/L 85-4E	1.25	1.00	7.00	1.25	0.866	1.339							
DSBNR/L 20-5E	1.25	1.25	7.00	1.25	1.063	1.614	SN □ □ 54 □ □						

Applicable toolholders to **TN** □ □ **D-type clamping**

DTGNR/L 91°







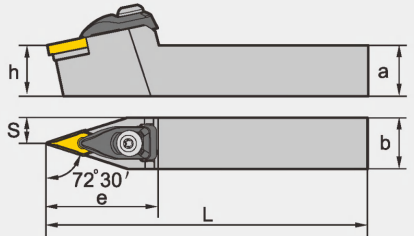

Type	Dimension(inch)						Applicable inserts  A48-50,A90-91	Clamping screw 	Shim 	Wrench 	Clamp 	Shim screw 	Spring 
	a	b	L	h	s	e							
DTGNR/L 10-3A	0.625	0.625	4.00	0.625	0.75	1.00	TN □ □ 33 □ □	CM5×22C	T16BM	WH30L	C1RA	SM5×8.65XA1	SPR6
DTGNR/L 12-3C	0.75	0.75	5.00	0.75	1.00	1.00							
DTGNR/L 16-3D	1.00	1.00	6.00	1.00	1.25	1.00							

Applicable toolholders to **VN** □ □ **D-type clamping**

DVVNN 72°30'









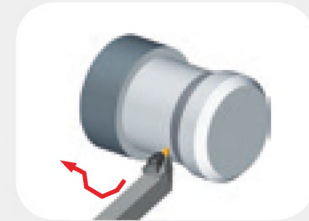
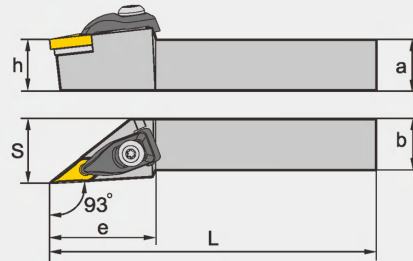

Type	Dimension(inch)						Applicable inserts  A51-53,A92-93	Clamping screw 	Shim 	Wrench 	Clamp 	Shim screw 	Spring 
	a	b	L	h	s	e							
DVVNN 12-3C	0.75	0.75	5.00	0.75	0.394	1.732	VN □ □ 33 □ □	CM5×22C	V16BM	WH30L	C6RA	SM5×8.65XA1	SPR6
DVVNN 16-3D	1.00	1.00	6.00	1.00	0.492	1.732							

Applicable toolholders to VN □ □

D-type clamping

DVJNR/L 93°









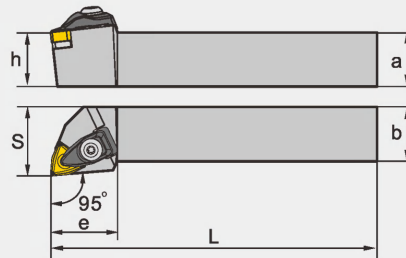

Type	Dimension(inch)						Applicable inserts  A51-53, A92-93	Clamping screw 	Shim 	Wrench 	Clamp 	Shim screw 	Spring 
	a	b	L	h	s	e							
DVJNR/L 12-3C	0.75	0.75	5.00	0.75	1.00	1.614	VN □ □ 33 □ □	CM5 ×22C	V16BM	WH30L	C6RA	SM5×8.65XA1	SPR6
DVJNR/L 16-3D	1.00	1.00	6.00	1.00	1.25	1.614							

Applicable toolholders to WN □ □

D-type clamping

DWLNR/L 95°







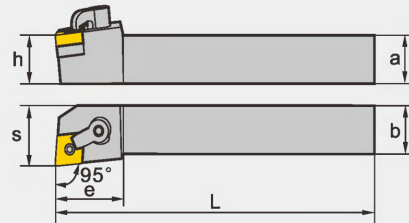

Type	Dimension(inch)						Applicable inserts  A53-56, A94-95	Clamping screw 	Shim 	Wrench 	Clamp 	Shim screw 	Spring 
	a	b	L	h	s	e							
DWLNR/L 10-3A	0.625	0.625	4.00	0.625	0.75	0.945	WN □ □ 33 □ □	CM5×22C	W06BM	WH30L	C1RA	SM5×8.65XA1	SPR6
DWLNR/L 12-3C	0.75	0.75	5.00	0.75	1.00	0.945							
DWLNR/L 16-3D	1.00	1.00	6.00	1.00	1.25	0.945							
DWLNR/L 12-4C	0.75	0.75	5.00	0.75	1.00	1.220	WN □ □ 43 □ □	CM6×25C	W08BM	WH40L	C2RA	SM6×10XA1	SPR4
DWLNR/L 16-4D	1.00	1.00	6.00	1.00	1.25	1.220							
DWLNR/L 85-4E	1.25	1.00	7.00	1.25	1.25	1.220							

Applicable toolholders to **CN** □ □ **M-Mult clamp**

MCLNR/L 95°







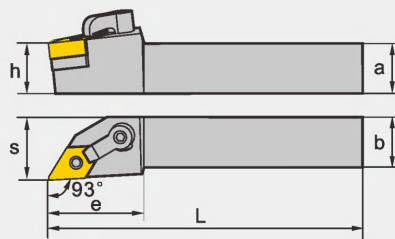
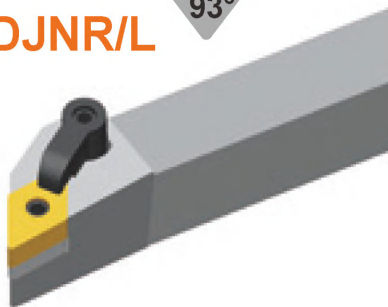

Type	Dimension(inch)						Applicable inserts  A30-35, A82-83	Clamping screw 	Shim 	Wrench 	Clamp 	Clamping stud 
	a	b	L	h	s	e						
MCLNR/L 12-4C	0.75	0.75	5.00	0.75	1.00	1.25	CN□□43□□	DM6×25	C12BM	WH30L	C1RD	TM6×17
MCLNR/L 16-4D	1.00	1.00	6.00	1.00	1.25	1.25		DM6×30				
MCLNR/L 85-4E	1.25	1.00	7.00	1.25	1.25	1.25						
MCLNR/L 16-5D	1.00	1.00	6.00	1.00	1.25	1.50	CN□□54□□	DM6×30	C16BM	WH30L	C2RD	TM8×21
MCLNR/L 20-5E	1.25	1.25	7.00	1.25	1.57	1.50	CN□□64□□	DM8×30X	C19BM	WH40L	C5RD	TM10×21
MCLNR/L 20-6E	1.25	1.25	7.00	1.25	1.57	1.77						
MCLNR/L 24-6F	1.50	1.50	8.00	1.50	2.00	1.77						

Applicable toolholders to **DN** □ □ **M-Mult clamp**

MDJNR/L 93°



Type	Dimension(inch)						Applicable inserts  A36-41, A84-86	Clamping screw 	Shim 	Wrench 	Clamp 	Clamping stud 
	a	b	L	h	s	e						
MDJNR/L 12-3C	0.75	0.75	5.00	0.75	1.00	1.25	DN□□33□□	DM6×25	D11BM	WH20L WH30L	C1RD	TM5×13
MDJNR/L 16-3D	1.00	1.00	6.00	1.00	1.25	1.25		DM6×30				
MDJNR/L 85-3E	1.25	1.00	7.00	1.25	1.25	1.25						
MDJNR/L 12-4C	0.75	0.75	5.00	0.75	1.00	1.50	DN□□44□□	DM6×25	D15BM	WH30L	C2RD	TM6×19
MDJNR/L 16-4D	1.00	1.00	6.00	1.00	1.25	1.50		DM6×30				
MDJNR/L 85-4E	1.25	1.00	7.00	1.25	1.25	1.50						
MDJNR/L 12-4C-3	0.75	0.75	5.00	0.75	1.00	1.50	DN□□43□□	DM6×25	D15BM	WH30L	C2RD	TM6×19
MDJNR/L 16-4D-3	1.00	1.00	6.00	1.00	1.25	1.50		DM6×30				
MDJNR/L 85-4E-3	1.25	1.00	7.00	1.25	1.25	1.50						

Applicable toolholders to TN □ □





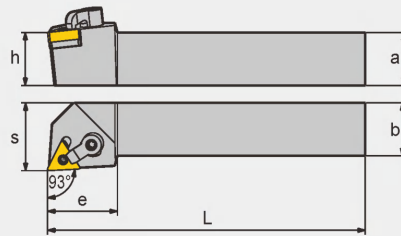

M-Mulit clamp

MTJNR/L

93°



A

Type	Dimension(inch)						Applicable inserts  A48-50,A90-91	Clamping screw 	Shim 	Wrench 	Clamp 	Clamping stud 
	a	b	L	h	s	e						
MTJNR/L 12-3C	0.75	0.75	5.00	0.75	1.00	1.25	TN □ □ 33 □ □	DM6×25	T16BM	WH20L WH30L	C1RD	TM5×13
MTJNR/L 16-3D	1.00	1.00	6.00	1.00	1.25	1.25		DM6×30				
MTJNR/L 85-3E	1.25	1.00	7.00	1.25	1.25	1.25						
MTJNR/L 16-4D	1.00	1.00	6.00	1.00	1.25	1.42	TN □ □ 43 □ □	DM6×30	T22BM	WH30L	C2RD	TM6×17
MTJNR/L 85-4E	1.25	1.00	7.00	1.25	1.25	1.42						





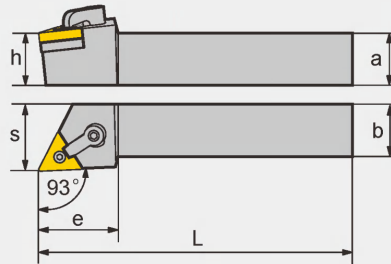

Applicable toolholders to TN □ □

M-Mulit clamp

MTJNR/L - Z

93°



Type	Dimension(inch)						Applicable inserts  A48-50,A90-91	Clamping screw 	Shim 	Wrench 	Clamp 	Clamping stud 
	a	b	L	h	s	e						
MTJNR/L 12-3C-Z	0.75	0.75	5.00	0.75	1.00	1.25	TN □ □ 33 □ □	DM6×25	T16BM	WH20L WH30L	C1RD	TM5×13
MTJNR/L 16-3D-Z	1.00	1.00	6.00	1.00	1.25	1.25		DM6×30				
MTJNR/L 85-3E-Z	1.25	1.00	7.00	1.25	1.25	1.25						
MTJNR/L 16-4D-Z	1.00	1.00	6.00	1.00	1.25	1.42	TN □ □ 43 □ □	DM6×30	T22BM	WH30L	C2RD	TM6×17
MTJNR/L 85-4E-Z	1.25	1.00	7.00	1.25	1.25	1.42						





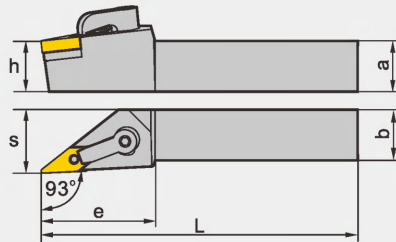

Applicable toolholders to VN □ □

M-Mult clamp

MVJNR/L

93°



Type	Dimension(inch)						Applicable inserts  A51-53, A92-93	Clamping screw 	Shim 	Wrench 	Clamp 	Clamping stud 
	a	b	L	h	s	e						
MVJNR/L 12-3C	0.75	0.75	5.00	0.75	1.00	1.77	VN □ □ 33 □ □	DM6×25	V16BM	WH20L WH30L	C3RD	TM5×13
MVJNR/L 16-3D	1.00	1.00	6.00	1.00	1.25	1.77						
MVJNR/L 85-3E	1.25	1.00	7.00	1.25	1.25	1.77	VN □ □ 33 □ □	DM6×30	V16BM	WH20L WH30L	C3RD	TM5×13
MVJNR/L 20-3E	1.25	1.25	7.00	1.25	1.57	1.77						





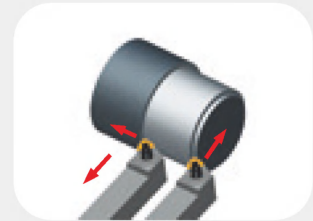
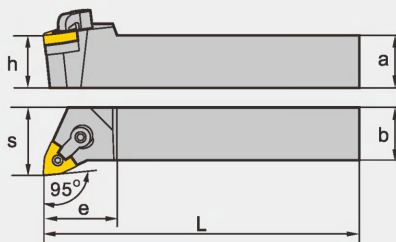
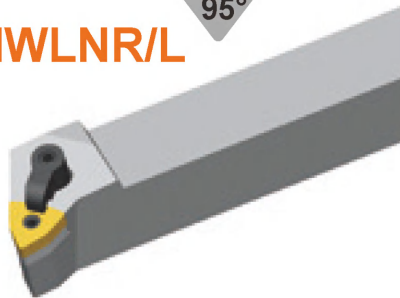

Applicable toolholders to WN □ □

M-Mult clamp

MWLNR/L

95°



Type	Dimension(inch)						Applicable inserts  A53-56, A94-95	Clamping screw 	Shim 	Wrench 	Clamp 	Clamping stud 
	a	b	L	h	s	e						
MWLNR/L 12-3C	0.75	0.75	5.00	0.75	1.00	1.18	WN □ □ 33 □ □	DM6×25	W06BM	WH20L	C1RD	TM5×13
MWLNR/L 16-3D	1.00	1.00	6.00	1.00	1.25	1.18		DM6×30				
MWLNR/L 12-4C	0.75	0.75	5.00	0.75	1.00	1.18	WN □ □ 43 □ □	DM6×25	W08BM	WH30L	C1RD	TM6×17
MWLNR/L 16-4D	1.00	1.00	6.00	1.00	1.25	1.38		DM6×30				
MWLNR/L 85-4E	1.25	1.00	7.00	1.25	1.25	1.38						
MWLNR/L 20-4E	1.25	1.25	7.00	1.25	1.50	1.38		DM6×30				

Applicable toolholders to **CC** □ □



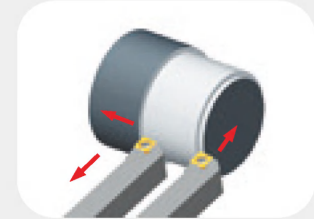
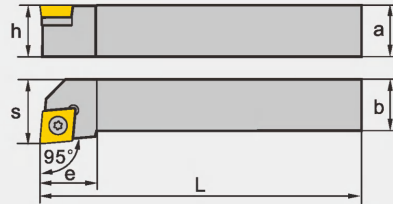

S-Screw clamp

SCLCR/L

95°



A

Type	Dimension(inch)						Applicable inserts  A57-59,A96,A108	Screw 	Shim 	Shim screw 	Shim Wrench 
	a	b	L	h	s	e					
SCLCR/L 05-2L	0.3125	0.3125	2.36	0.3125	0.39	0.39	CC □ □ 2(1.5) □ □	I60M2.5×6.5	--	--	WT07IP
SCLCR/L 06-2K	0.375	0.375	2.75	0.375	0.47	0.39					
SCLCR/L 08-3J	0.50	0.50	3.50	0.50	0.63	0.63					
SCLCR/L 10-3A	0.625	0.625	4.00	0.625	0.79	0.63	CC □ □ 3(2.5) □ □	I60M3.5×8	--	--	WT15IP
SCLCR/L 12-4C	0.75	0.75	5.00	0.75	1.00	1.00					
SCLCR/L 16-4D	1.00	1.00	6.00	1.00	1.25	1.02	CC □ □ 43 □ □	I60M4×11X	C12BS	SM6×10XA	WT15IP WT40L
SCLCR/L 85-4E	1.25	1.00	7.00	1.25	1.25	1.02					





Applicable toolholders to **DC** □ □

S-Screw clamp

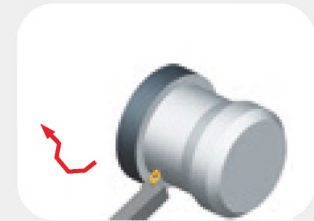
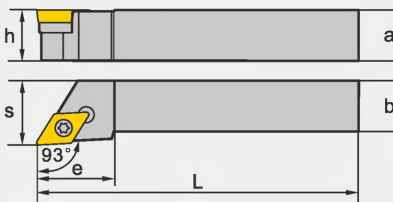
SDJCR/L

93°



Type	Dimension(inch)						Applicable inserts  A60-62,A97,A109	Screw 	Shim 	Shim screw 	Wrench 
	a	b	L	h	s	e					
SDJCR/L06-2K	0.375	0.375	2.75	0.375	0.47	0.60	DC □ □ 2(1.5) □ □	I60M2.5×6.5	--	--	WT07IP
SDJCR/L08-2J	0.50	0.50	3.50	0.50	0.63	0.60					
SDJCR/L10-2A	0.625	0.625	4.00	0.625	0.79	0.71					
SDJCR/L10-3A	0.625	0.625	4.00	0.625	0.79	0.95	DC □ □ 3(2.5) □ □	I60M3.5×12	D11BS	SM5×8.65XA	WT15IP WH35L
SDJCR/L12-3C	0.75	0.75	5.00	0.75	1.00	0.95					
SDJCR/L16-3D	1.00	1.00	6.00	1.00	1.25	1.14					
SDJCR/L85-3E	1.25	1.00	7.00	1.25	1.25	1.44					





Applicable toolholders to VB□□

S-Screw clamp

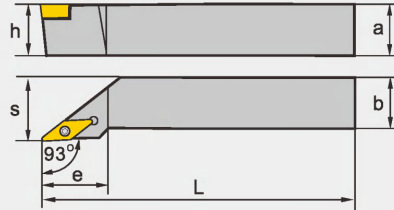
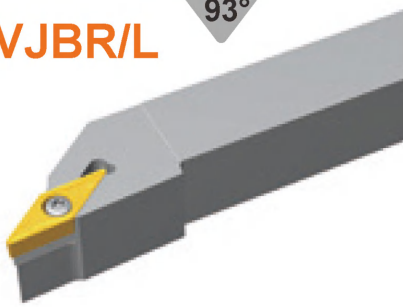
SVJBR/L

93°



Type	Dimension(inch)						Applicable inserts  A70-71,A99,A111	Screw 	Shim 	Shim screw 	Wrench 
	a	b	L	h	s	e					
SVJBR/L 08-2J	0.50	0.50	3.50	0.50	0.63	1.06	VB□□2(1.5)□□	I60M2.5×6.5	--	--	WT07IP
SVJBR/L 10-2A	0.625	0.625	4.00	0.625	0.79	1.06					
SVJBR/L 12-2C	0.75	0.75	5.00	0.75	1.00	1.06					
SVJBR/L 16-2D	1.00	1.00	6.00	1.00	1.25	1.06					
SVJBR/L 10-3A	0.625	0.625	4.00	0.625	0.79	1.42	VB□□33□□	I60M3.5×12	V16BS	SM5×8.65XA	WT15IP WH35L
SVJBR/L 12-3C	0.75	0.75	5.00	0.75	1.00	1.61					
SVJBR/L 16-3D	1.00	1.00	6.00	1.00	1.25	1.61					
SVJBR/L 85-3E	1.25	1.00	7.00	1.25	1.25	1.61					





Applicable toolholders to VB□□

S-Screw clamp

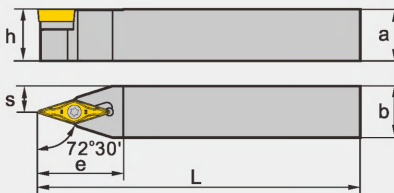
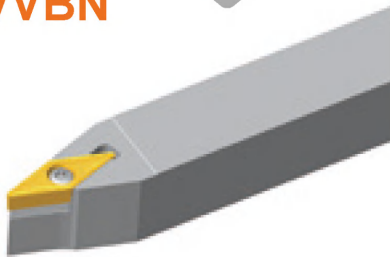
SVVBN

72°30'



Type	Dimension(inch)						Applicable inserts  A70-71,A99,A111	Screw 	Shim 	Shim crew 	Wrench 
	a	b	L	h	s	e					
SVVBN 08-2J	0.50	0.50	3.50	0.50	0.24	1.06	VB□□2(1.5)□□	I60M2.5×6.5	--	--	WT07IP
SVVBN 10-2A	0.625	0.625	4.00	0.625	0.31	1.06					
SVVBN 12-2C	0.75	0.75	5.00	0.75	0.39	1.18					
SVVBN 10-3A	0.625	0.625	4.00	0.625	0.31	1.30	VB□□33□□	I60M3.5×12	V16BS	SM5×8.65XA	WT15IP WH35L
SVVBN 12-3C	0.75	0.75	5.00	0.75	0.39	1.30					
SVVBN 16-3D	1.00	1.00	6.00	1.00	0.49	1.50					

Applicable toolholders to VC□□□□



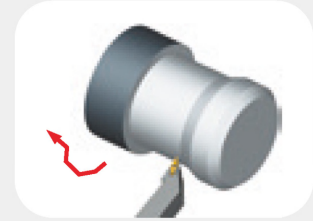
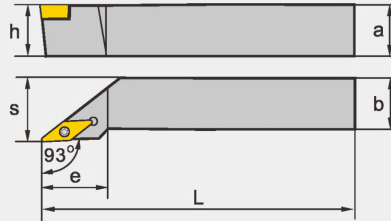

S-Screw clamp

SVJCR/L

93°



A

Type	Dimension(inch)						Applicable inserts  A68-69,A100,A112	Screw 	Shim 	Shim screw 	Wrench 
	a	b	L	h	s	e					
SVJCR/L 06-2L	0.375	0.375	2.36	0.375	0.47	0.87	VC□□22□□	I60M2.5×6.5	--	--	WT07IP
SVJCR/L 08-2J	0.50	0.50	3.50	0.50	0.63	1.06					
SVJCR/L 10-2A	0.625	0.625	4.00	0.625	0.79	1.06					
SVJCR/L 12-2C	0.75	0.75	5.00	0.75	1.00	1.06					
SVJCR/L 16-2D	1.00	1.00	6.00	1.00	1.25	1.06					
SVJCR/L 10-3A	0.625	0.625	4.00	0.625	0.79	1.42	VC□□33□□	I60M3.5×12	V16BS	SM5×8.65XA	WT15IP WH35L
SVJCR/L 12-3C	0.75	0.75	5.00	0.75	1.00	1.61					
SVJCR/L 16-3D	1.00	1.00	6.00	1.00	1.25	1.61					
SVJCR/L 85-3E	1.25	1.00	7.00	1.25	1.25	1.61					

Applicable toolholders to TC□□

S-Screw clamp





STGCR/L

91°

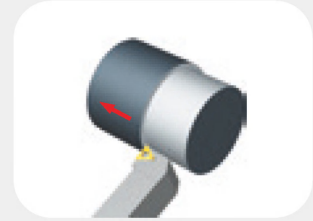
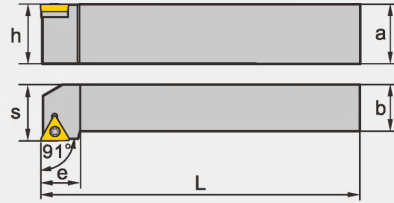

R-type shown



Type	Dimension(inch)						Applicable inserts  A65-67, A98, A110	Screw 	Shim 	Shim screw 	Wrench 
	a	b	L	h	s	e					
STGCR/L 05-1.8L	0.3125	0.3125	2.36	0.3125	0.39	0.43	TC□□1.8(1.5)□□	I60M2.2×5.5	--	--	WT06IP
STGCR/L 06-1.8L	0.375	0.375	2.36	0.375	0.47	0.43	TC□□1.8(1.5)□□	I60M2.2×5.5	--	--	WT06IP
STGCR/L 08-2J	0.50	0.50	3.50	0.50	0.63	0.55	TC□□2(1.5)□□	I60M2.5×6.5	--	--	WT07IP
STGCR/L 10-2A	0.625	0.625	4.00	0.625	0.79	0.63	TC□□2(1.5)□□	I60M2.5×6.5	--	--	WT07IP
STGCR/L 12-3C	0.75	0.75	5.00	0.75	1.00	0.83	TC□□3(2.5)□□	I60M3.5×12	T16BS	SM5×8.65XA	WT15IP WH35L
STGCR/L 16-3D	1.00	1.00	6.00	1.00	1.25	0.83	TC□□3(2.5)□□	I60M3.5×12	T16BS	SM5×8.65XA	WT15IP WH35L

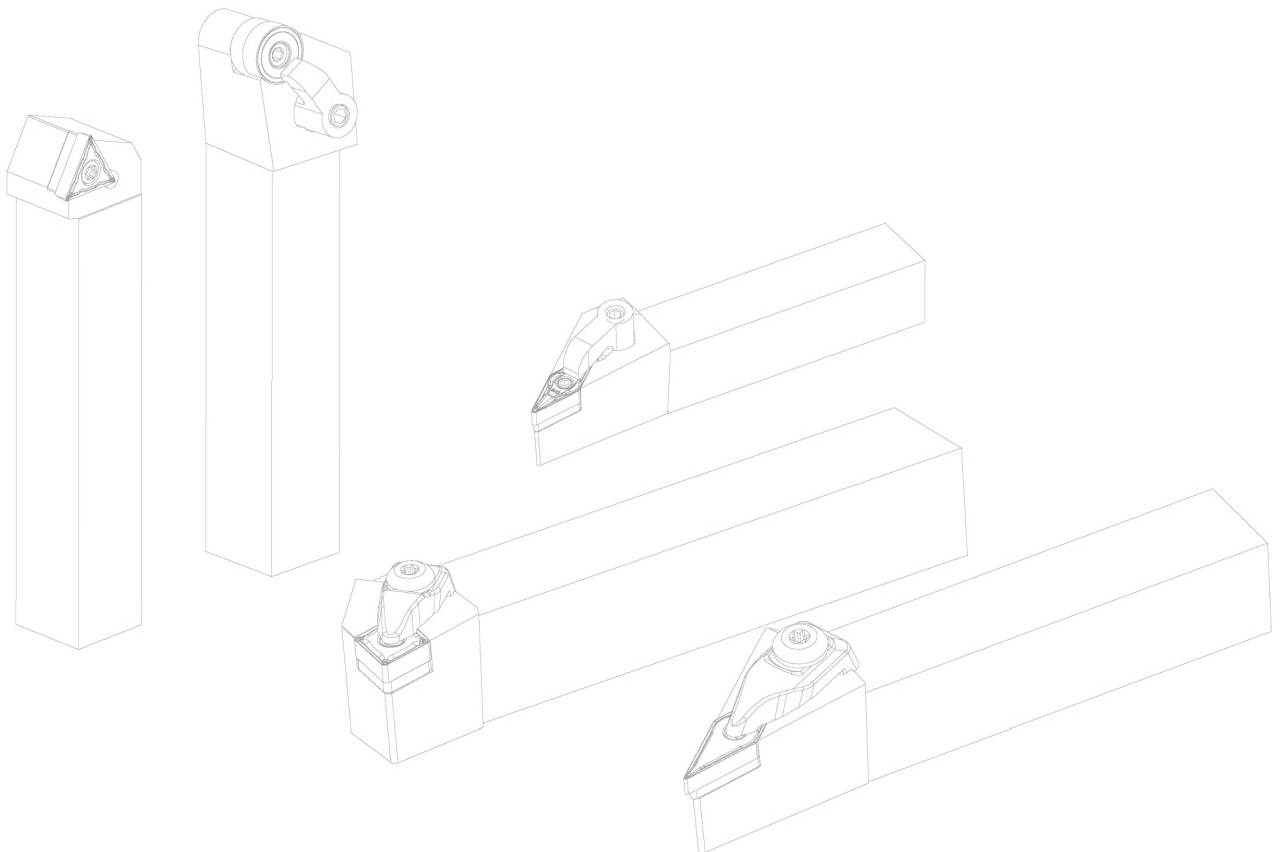

Internal turning tools

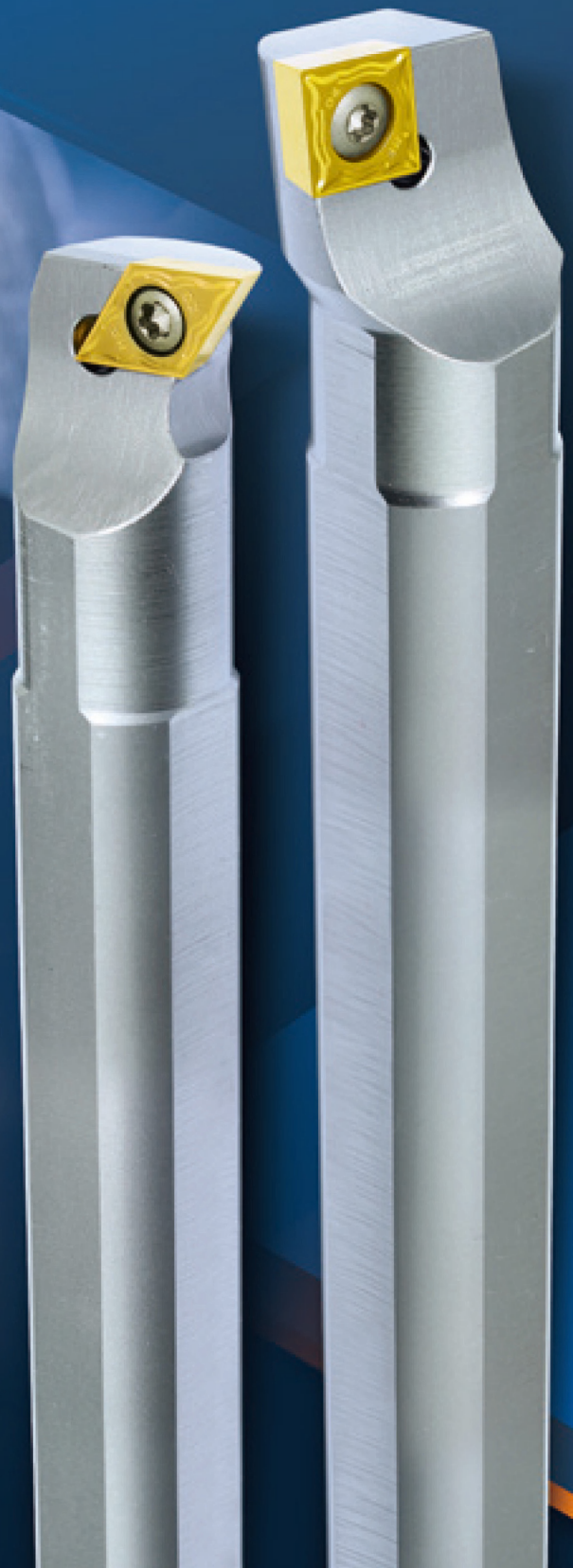

Boring Bars code key

Boring bars type	Boring bars diameter	Boring bars length	Insert shape	
Steel with cooling hole A	 Round shanks: shown in 1/16" increments		 C	 D
Carbide C	04 = 0.250" 05 = 0.3125" 06 = 0.375" 08 = 0.500" 10 = 0.625" 12 = 0.750" 16 = 1.000" 20 = 1.250" 24 = 1.500" 32 = 2.000" 40 = 2.500"	H = 4" J = 4-1/2" K = 5" M = 6" Q = 7" R = 8" S = 10" T = 12" U = 14" V = 16" Y = 20"	 K	 R
Carbide with cooling hole E			 S	 T
Steel S			 V	 W

S 16 T - S C L C R - 3

Insert mounting method	Boring bars style	Insert clearance angle	Cutting direction	Insert I.C size
 P-Lever Clamp	 K	 B	 L-Left hand	 Number of 1/8" of inscribed circle
 M-multi Clamp	 F	 C		
 S-Screw Clamp	 U	 D	 R-Right hand	2 = 0.250"
 C-Top Clamp	 L	 E		3 = 0.375"
	 Q	 N		4 = 0.500"
		 P		5 = 0.625"
				6 = 0.750"
				7 = 0.875"
				8 = 1.000"



Applicable Boring bars to **CN**□□

PCLNR/L

95°

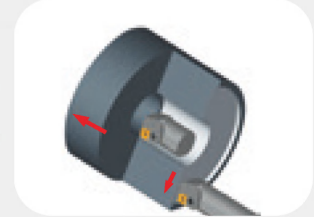
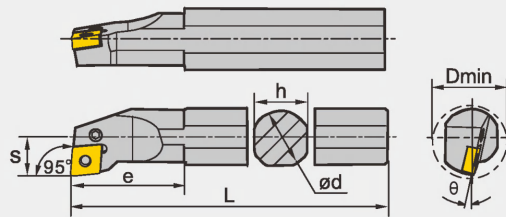

Type	Dimension(inch)							Applicable inserts A30-35,A82-83	Screw	Wrench	Lever	Shim	Shim pin
	Dmin	ød	h	L	S	θ	e						
S16Q-PCLNR/L-3	1.26	1.00	0.906	7	0.669	-10°	1.378	CN□□32□□	LEM5×9B	WH20L	L3C	--	--
S16T-PCLNR/L-3	1.26	1.00	0.906	12	0.669	-10°	1.378						
S16Q-PCLNR/L-4	1.26	1.00	0.906	7	0.669	-12°	1.575	CN□□43□□	LEM6×13.4A	WH25L	L4A	--	--
S16T-PCLNR/L-4	1.26	1.00	0.906	12	0.669	-12°	1.575						

Applicable Boring bars to **DN**□□

PDUNR/L

93°

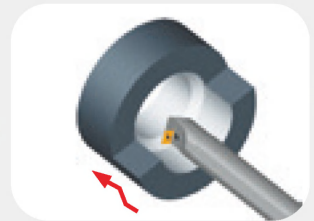
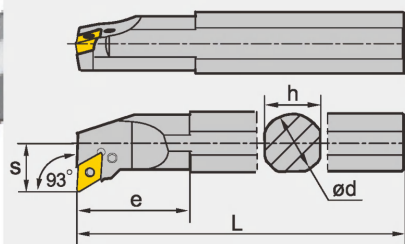

Type	Dimension(inch)							Applicable inserts A36-41,A84-86	Screw	Wrench	Lever	Shim	Shim pin
	Dmin	ød	h	L	S	θ	e						
S16Q-PDUNR/L-3	1.26	1.00	0.906	7	0.669	-13°	1.378	DN□□33□□	LEM5×12B	WH20L	L3D	--	--
S16T-PDUNR/L-3	1.26	1.00	0.906	12	0.669	-13°	1.378						

Applicable toolholders to **SN**□□

PSKNR/L

75°

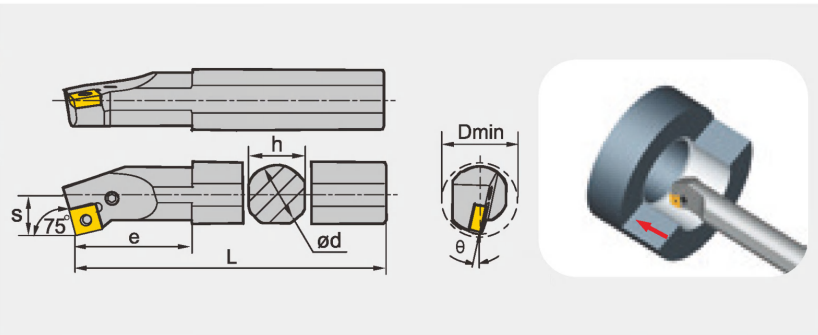

Type	Dimension(inch)							Applicable inserts	Screw	Wrench	Lever	Shim	Shim pin
	Dmin	ød	h	L	S	θ	e						
S16Q-PSKNR/L-4	1.26	1.00	0.906	7	0.669	-12°	1.654	 A42-47, A87-89	 LEM6×13.4A	 WH25L	 L4A	 --	 --
S16T-PSKNR/L-4	1.26	1.00	0.906	12	0.669	-12°	1.654						
A16R-PSKNR/L-4	1.26	1.00	0.945	8	0.669	-12°	1.654						

Applicable Boring bars to **TN**□□

PTFNR/L

90°

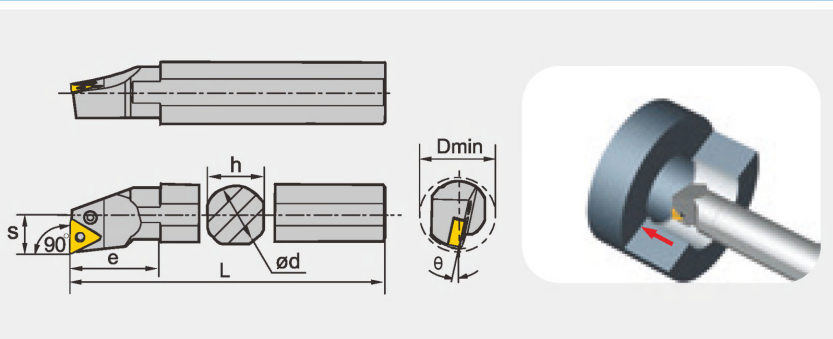

Type	Dimension(inch)							Applicable inserts	Screw	Wrench	Lever	Shim	Shim pin
	Dmin	ød	h	L	S	θ	e						
S16Q-PTFNR/L-2	1.26	1.00	0.906	7	0.669	-10°	1.378	 A48-50, A90-91	 LEM5×9B	 WH20L	 L2	 --	 --
S16T-PTFNR/L-2	1.26	1.00	0.906	12	0.669	-10°	1.378						
S16Q-PTFNR/L-3	1.26	1.00	0.906	7	0.669	-12°	1.654	 TN□□33□□	 LEM5×12B	 WH20L	 L3B	 --	 --
S16T-PTFNR/L-3	1.26	1.00	0.906	12	0.669	-12°	1.654						





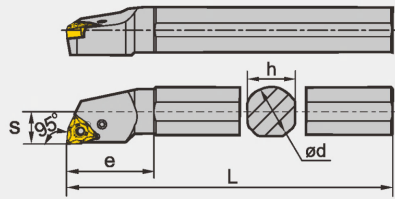

Applicable toolholders to WN□□

PWLNR/L

95°



A

Type	Dimension(inch)							Applicable inserts  A53-56,A90-91	Screw 	Wrench 	Lever 	Shim 	Shim pin 
	Dmin	ød	h	L	S	θ	e						
S16Q-PWLNR/L-3	1.26	1.00	0.906	7	0.669	-13°	1.378	WN□□3(2.5)□□	LEM5×12B	WH20L	L3B	--	--
S16T-PWLNR/L-3	1.26	1.00	0.906	12	0.669	-13°	1.378	WN□□33□□					
S16Q-PWLNR/L-4	1.26	1.00	0.906	7	0.669	-13°	1.772	WN□□43□□	LEM6×13.4A	WH25L	L4A	--	--
S16T-PWLNR/L-4	1.26	1.00	0.906	12	0.669	-13°	1.772						

Applicable Boring bars to **CC**□□

SCLCR/L

95°

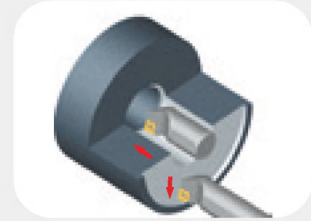
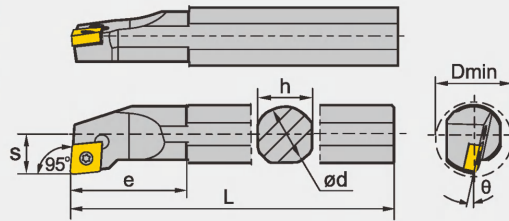





Type	Dimension(inch)							Applicable inserts A57-59,A96,A108	Screw	Wrench	Shim	Shim screw
	Dmin	ød	h	L	S	θ	e					
S05K-SCLCR/L-2	0.394	0.3125	0.276	5	0.197	-15°	0.551	CC□T2(1.5)□	I60M2.5×5.5	WT07IP	--	--
S06M-SCLCR/L-2	0.472	0.375	0.354	6	0.236	-13°	0.551					
S08M-SCLCR/L-2	0.630	0.500	0.433	6	0.354	-10°	0.984	CC□T3(2.5)□	I60M3.5×8	WT15IP	--	--
S08M-SCLCR/L-3	0.630	0.500	0.433	6	0.354	-10°	0.984					
S10M-SCLCR/L-3	0.787	0.625	0.594	6	0.433	-12°	1.280	CC□T3(2.5)□	I60M3.5×10	WT15IP	--	--
S10R-SCLCR/L-3	0.787	0.625	0.591	8	0.433	-12°	1.280					
S12Q-SCLCR/L-3	0.787	0.750	0.709	7	0.512	-8°	1.496	CC□T43□	I60M4×11X	WT15IP	--	--
S12S-SCLCR/L-3	0.984	0.750	0.709	10	0.512	-8°	1.496					
S16Q-SCLCR/L-3	1.260	1.000	0.906	7	0.669	-6°	1.772	CC□T43□	I60M4×11X	WT15IP	--	--
S16T-SCLCR/L-3	1.260	1.000	0.906	12	0.669	-6°	1.772					
S16Q-SCLCR/L-4	1.260	1.000	0.921	7	0.669	-6°	1.772	CC□T43□	I60M4×11X	WH40L WT15IP	C12BS	SM6×10XA
S16T-SCLCR/L-4	1.260	1.000	0.921	12	0.669	-6°	1.772					
S20R-SCLCR/L-4	1.575	1.250	1.171	8	0.866	-10°	1.969	CC□T43□	I60M4×11X	WH40L WT15IP	C12BS	SM6×10XA
S20U-SCLCR/L-4	1.575	1.250	1.171	14	0.866	-10°	1.969					
S24S-SCLCR/L-4	1.969	1.500	1.382	10	10.63	-8°	2.362	CC□T43□	I60M4×11X	WH40L WT15IP	C12BS	SM6×10XA
S24V-SCLCR/L-4	1.969	1.500	1.382	16	1.063	-8°	2.362					
A05F-SCLCR/L-2	0.394	0.315	0.295	3.15	0.197	-15°	0.551	CC□T2(1.5)□	I60M2.5×5.5	WT07IP	--	--
A08K-SCLCR/L-3	0.630	0.500	0.453	5	0.354	-10°	0.984	CC□T3(2.5)□	I60M3.5×8	WT15IP	--	--

Applicable Boring bars to DC□□

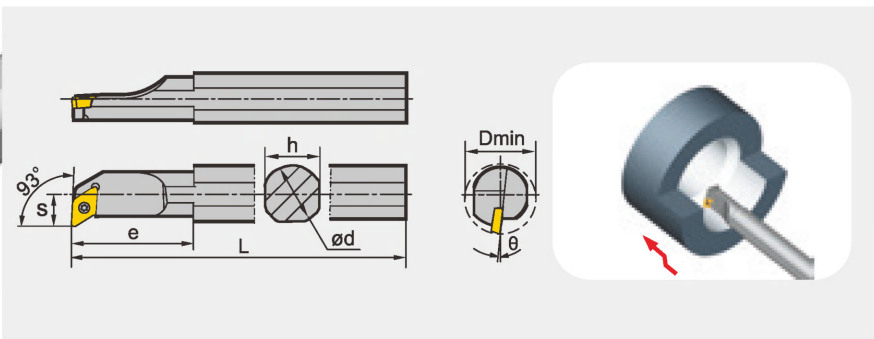
SDUCR/L

93°



Type	Dimension(inch)							Applicable inserts  A60-60,A97,A109	Screw 	Wrench 
	Dmin	ød	h	L	S	θ	e			
S06M-SDUCR/L-2	0.512	0.375	0.354	6	0.276	-8°	0	DC□T2(1.5)□	I60M2.5×5.5	WT071P
S08M-SDUCR/L-2	0.630	0.500	0.433	6	0.354	-8°	0.866		I60M2.5×6.5	
S10M-SDUCR/L-2	0.787	0.625	0.591	6	0.433	-6°	1.063		I60M2.5×6.5	
S10R-SDUCR/L-2	0.787	0.625	0.591	8	0.433	-6°	1.063	DC□T3(2.5)□	I60M3.5×8	WT151P
S12Q-SDUCR/L-3	0.984	0.750	0.709	7	0.512	-6°	1.575			
S12S-SDUCR/L-3	0.984	0.750	0.709	10	0.512	-6°	1.575			
S16Q-SDUCR/L-3	1.260	1.000	0.906	7	0.669	-6°	1.811			
S16T-SDUCR/L-3	1.260	1.000	0.906	12	0.669	-6°	1.811			

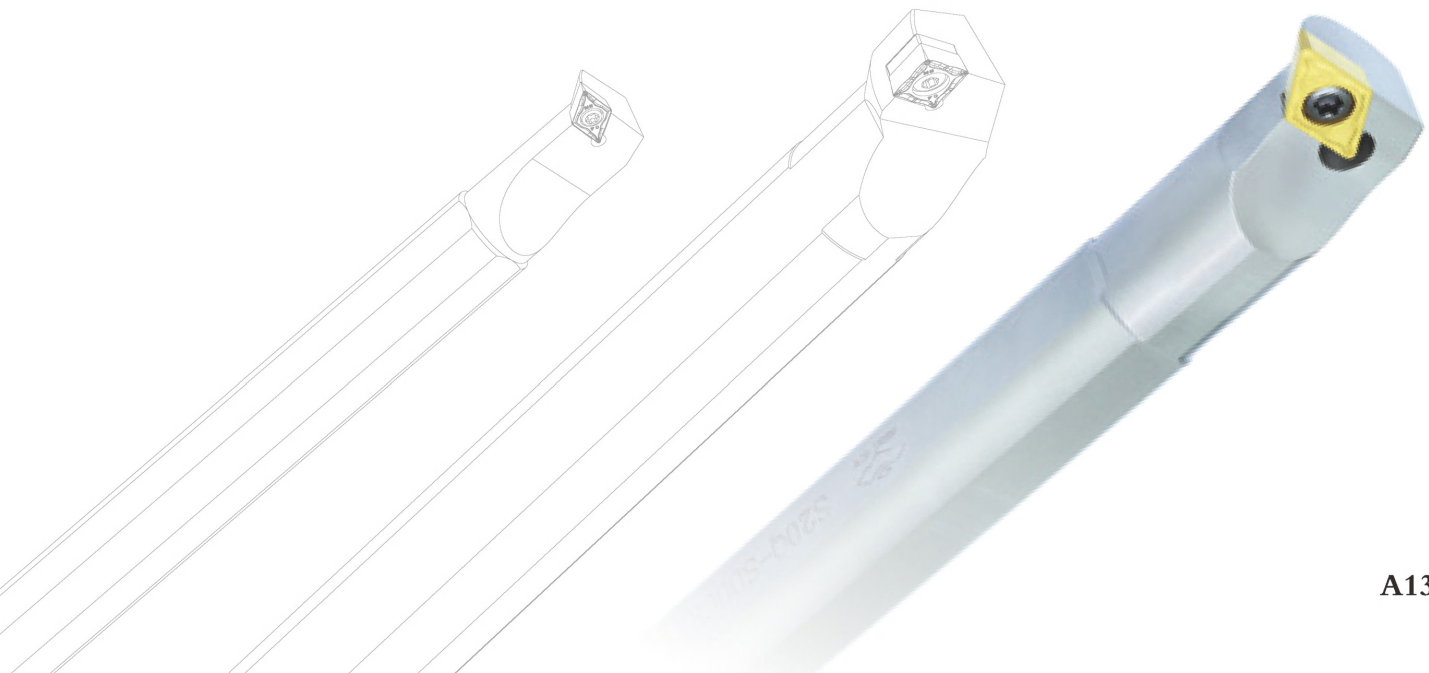

Applicable Boring bars to TC□□

STFCR/L

91°

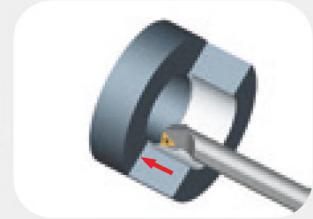
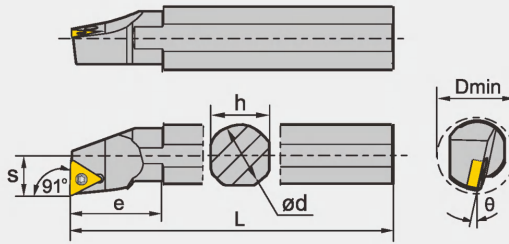

Type	Dimension(inch)							Applicable inserts A65-67, A98, A110	Screw	Wrench	Shim	Shim screw
	Dmin	ød	h	L	S	θ	e					
S08M-STFCR/L-2	0.630	0.500	0.433	6	0.354	-10°	1.181	TC□T2(1.5)□	I60M2.5×6.5	WT07IP	--	--
S10M-STFCR/L-2	0.787	0.625	0.591	6	0.433	-6°	1.378					
S10R-STFCR/L-2	0.787	0.625	0.591	8	0.433	-6°	1.378					
S12Q-STFCR/L-2	0.984	0.750	0.709	7	0.512	-3°	1.417					
S12S-STFCR/L-2	0.984	0.750	0.709	10	0.512	-3°	1.417					
S16Q-STFCR/L-3	1.260	1.000	0.906	7	0.669	-6°	1.929	TC□T3(2.5)□	I60M3.5×10	WT15IP	--	--
S16T-STFCR/L-3	1.260	1.000	0.906	12	0.669	-6°	1.292					
S20R-STFCR/L-3	1.575	1.250	1.181	8	0.866	-10°	1.969					
S20U-STFCR/L-3	1.575	1.250	1.181	14	0.866	-10°	1.969					
S24S-STFCR/L-3	1.969	1.500	1.3779	10	1.063	-8°	2.362					
S24V-STFCR/L-3	1.969	1.500	1.3779	16	1.063	-8°	2.362	TC□T3(2.5)□	I60M3.5×12	WT15IP WH35L	T16BS	SM5×8.65XA
A08K-STFCR/L-2	0.630	0.500	0.453	5	0.354	-10°	1.024					
A10M-STFCR/L-2	0.787	0.625	0.610	6	0.433	-6°	1.181					
A12Q-STFCR/L-2	0.984	0.750	0.748	7	0.512	-3°	1.417					
A16R-STFCR/L-3	1.260	1.000	0.946	8	0.669	-6°	1.772					
A20S-STFCR/L-3	1.575	1.250	1.220	10	0.866	-10°	1.929	TC□T3(2.5)□	I60M3.5×12	WT15IP/WH35L	T16BS	SM5×8.65XA



Recommended cutting parameters for general turning

ISO	Materials		Hardness HB	CVD Coating						PVD Coating			Cermet	Coated cermet	
				YBC103	YBC203	YBC152	YBC252	YBC351	YBC352	YBG102	YBG202	YBG205	YNG151	YNG151C	
				Feed rate (inch/rev)											
				0.004-0.024	0.004-0.031	0.004-0.024	0.004-0.031	0.008-0.039	0.008-0.039	0.008-0.016	0.004-0.024	0.002-0.031	0.002-0.008	0.002-0.008	
Cutting speed (SFPM)															
P	Carbon steel	C=0.15%	125	1650-900	1600-800	1650-900	1600-800	1200-550	1400-700	1500-700	1200-600	1200-500	1800-1100	1900-1100	
		C=0.35%	150	1500-800	1500-750	1500-800	1500-750	1000-500	1100-650	1400-700	1000-550	1000-550	1600-1000	1700-1000	
		C=0.60%	200	1300-700	1300-650	1300-700	1300-650	850-400	1000-600	1200-600	850-500	900-550	1500-850	1600-850	
	Alloy steel	Anneal	180	1300-600	1300-650	1300-600	1300-650	650-300	800-500	1200-600	650-400	700-450	1300-800	1400-800	
		Hardened	275	900-500	850-450	900-500	850-450	450-230	650-400	800-400	450-300	500-300	1000-600	1000-600	
		Hardened	300	850-500	800-400	850-500	800-400	400-200	600-350	700-300	400-260	450-300	800-560	900-550	
	High alloy steel	Hardened	350	750-400	700-400	750-400	700-400	350-200	500-300	650-300	360-240	400-260	800-500	800-500	
		Anneal	200	1200-600	1000-550	1200-600	1000-550	550-260	700-400	1000-500	600-300	600-300	1100-650	1200-650	
	Cast steel	Hardene	325	600-400	500-300	600-400	500-300	300-130	450-300	400-260	300-200	300-200	550-360	600-360	
		Non-Alloy	180	900-500	800-450	900-500	800-450	450-240	600-400	750-400	450-300	450-300	850-560	1000-550	
		Low alloy	200	900-350	700-350	900-350	700-350	400-260	550-400	650-300	400-300	400-350	850-560	1000-550	
		High alloy	225	700-350	600-300	700-350	600-300	300-180	500-350	550-260	300-180	300-200	850-300	900-300	

ISO	Materials		Hardness HB	CVD Coating				PVD Coating			Cermet	Coated cermet		
				YBM151	YBM153	YBM251	YBM253	YBM215	YBG202	YBG205	YNG151	YNG151C		
				Feed rate (inch/rev)										
				0.008-0.024	0.008-0.024	0.008-0.024	0.008-0.024	0.008-0.016	0.004-0.016	0.008-0.016	0.004-0.012	0.004-0.012		
Cutting speed (SFPM)														
M	Stainless steel	Ferrite	180	900-600	900-600	800-450	850-450	1000-650	1000-600	1000-650	1100-700	1100-700		
		Austenite	260	800-500	800-500	650-360	700-360	900-550	800-500	900-550	800-500	900-450		
		Martensite	330	650-450	650-450	700-400	750-400	850-500	850-550	850-500	900-550	1000-500		

● Recommended cutting parameters for general turning

ISO	Materials		Hardness HB	CVD Coating					Cermet	Coated cermet		
				YBD052	YBD151	YBD102	YBD152	YBD252	YNG151	YNG151C		
				Feed rate(inch/rev)								
				0.004-0.016	0.004-0.024	0.004-0.016	0.004-0.020	0.004-0.031	0.004-0.016	0.004-0.016		
		Cutting speed(SFPM)										
K	Malleable cast iron	Ferrite	130	1150-750	1000-700	1000-700	1050-350	800-550	1000-500	1000-600		
		Pearlite	230	800-350	700-300	750-300	750-300	600-250	700-400	800-500		
	Low cast iron		180	1700-650	1500-600	1500-650	1600-600	1250-500	1300-800	1400-900		
	High cast iron		260	750-400	700-350	700-400	700-300	550-300	1200-800	1200-850		
	Nodular Cast iron	Ferrite	160	1000-500	1000-450	1000-500	950-450	700-350	1100-600	1200-700		
		Pearlite	250	750-350	700-300	700-350	700-300	550-300	1000-650	1100-700		

ISO	Materials		Hardness HB	PVD Coating					Cemented carbide		
				YBG102	YBG105	YBG202	YBS103	YBG212	YD101		
				Feed rate (inch/rev)							
				0.002-0.006						0.002-0.014	
		Cutting speed (SFPM)									
N	Al alloy	No heat treatment	60						5700-2600		
		Heat treatment	100						1700-800		
	Cast aluminum alloy	No heat treatment	75						1500-600		
		Heat treatment	90						1000-360		
	Copper alloy	Lead alloy	110						2000-650		
		Copper, pure copper	90						1000-650		
Copper, nonleaded Copper, electrolytic copper		100						700-400			
S	Ni-base alloy	Ni-base alloy	40	300-100	300-130	300-100	300-70	300-100	230-70		

● Frequent problems of turning and solutions

Common problem	Cause	Solutions		Cutting conditions							Tool shape				Machine clamping system		
		Harder materials	Tougher materials	Cutting speed	Feed rate	Cutting depth	Cutting liquid	Change chipbreaker of inserts	Rake face	Nose radius	Approach angle	Cutting edge strength	Increase precision of inserts	Increase rigidity of tool holder	Clamping of toolholder and workpiece	Overhang of toolholder	Power, gap
Over abrasion on nose	Bad precision during machining	✓								↑							
	Unsuitable cutting conditions			↓	↑												
Surface precision deterioration	Abrasion intensified and cutting edge not sharp enough	✓		↓			✓		↑	↑		↓	✓				
	Breakage		✓		↓	↓		✓		↑		↑			✓	✓	✓
	Unsuitable geometrical shape of cutting edge							✓		↑		↓	✓				
	Unsuitable cutting conditions			↑	↓	↓	✓										
	Shake and vibration		✓	↑	↓	↓	✓	✓	↑	↓	↑	↓		✓	✓	✓	✓
	Built-up edge			↑	↑		✓	✓	↑			↓	✓				
Radiation	Effect of cutting heat			↓	↓	↓											
	Unsuitable geometrical shape of cutting edge	✓						✓	↑			↓					
Bad precision of dimensions	Dimensions fluctuate during cutting												✓				
	Location removed of workpiece or tools							✓	↑	↓	↑			✓	✓	✓	✓
Breakage	Abrasion intensified on flank and rake face	✓		↓				✓	↑	↑		↓					
	Abrasion on rake face	✓		↓	↓	↓		✓	↑		↓						
	Light breakage		✓		↓	↓		✓			↓	↑		✓	✓	✓	✓
	Built-up edge			↑	↑		✓	✓	↑			↓	✓				
	Thermal cracking			↓	↓	↓	✓	✓	↑			↓					
	Cutting edge nose deformation	✓		↑	↓	↓	✓	✓	↑	↑	↓	↓					
	Tool life		✓		↓	↓		✓		↑	↓	↑		✓	✓	✓	✓
Chip controlling	Intertwist of long chips			↓	↑	↑	✓				↓	↑					
	Unsuitable geometry							✓		↓	↑						
	Too short chips lead to splash				↓	↓	✓				↑	↓					
Burr and knockdown flange	Steel and Al, burrs occurring			↑	↓		✓										
	Unsuitable tool abrasion and geometrical shape	✓						✓	↑	↓	↑	↓					
	Cast iron, knockdown flange			↓	↑		✓										
	Unsuitable tool abrasion and geometrical shape	✓						✓	✓	↓	↓	↓					
	Soft steel, raw edges				↓	↓											
	Unsuitable tool abrasion and geometrical shape	✓						✓	↑	↑		↑		✓	✓	✓	✓

