

# Milling Tools







**UM** series



Cutting tools

## **SOLID CARBIDE CUTTING TOOLS**

<b>Overview of end mills</b>	<b>P312-313</b>
<b>Code key of end mills</b>	<b>P314</b>
<b>GM series end mills</b>	<b>P314-323</b>
<b>HMX series end mills</b>	<b>P324-327</b>
<b>AL series end mills</b>	<b>P328-329</b>
<b>UM series end mills</b>	<b>P330-332</b>
<b>VSM series end mills</b>	<b>P333-336</b>
<b>Cutting parameters of GM series end mills</b>	<b>P337-343</b>
<b>Cutting parameters of HMX series end mills</b>	<b>P344-347</b>
<b>Cutting parameters of AL series end mills</b>	<b>P348-350</b>
<b>Cutting parameters of UM series end mills</b>	<b>P351-353</b>
<b>Cutting parameters of VSM series end mills</b>	<b>P354-355</b>

### Product overview of solid carbide end mills

#### ● GM for universal machining



#### ● HMX for high-hardness material machining

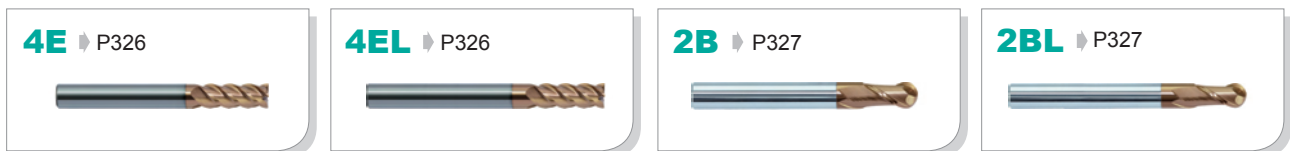

### ● AL For aluminium alloy machining

**2E** ▶ P328



**3E** ▶ P328



**2B** ▶ P329



**2R-AIR** ▶ P329



### ● UM High performance universal milling

**4E** ▶ P331



**4EL** ▶ P331



**4R** ▶ P332



### ● VSM for hard-to-cut materials milling

**4E** ▶ P334



**4EL** ▶ P334



**4EFP** ▶ P335



**4R** ▶ P335



**4RL** ▶ P336



**4RFP** ▶ P336



## Code key of end mills

### Series of tools

- GM > Universal machining
- HMX > High-hardness materials machining
- AL > For aluminium alloy machining
- UM > High performance universal milling
- VSM > Hard-to-cut materials machining

### Number of teeth

### Type of tools

- E > Flattened end mill
- B > Ball nose end mill
- R > R end mill

**GM - 2 E L - 1/4" R015**

Radius

Diameter of tools

### Series of lengths

- L > Long series
- S > Tiny diameter
- F > Short cutting edge
- Default > series of standard length

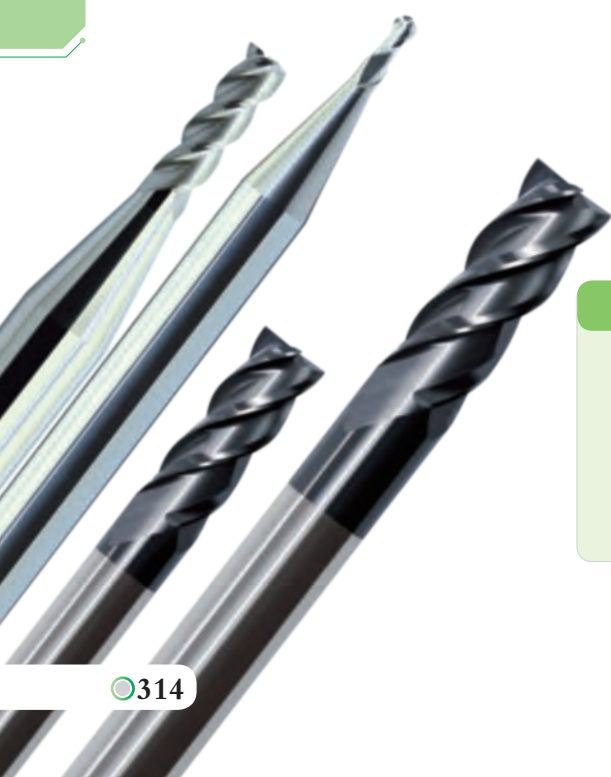
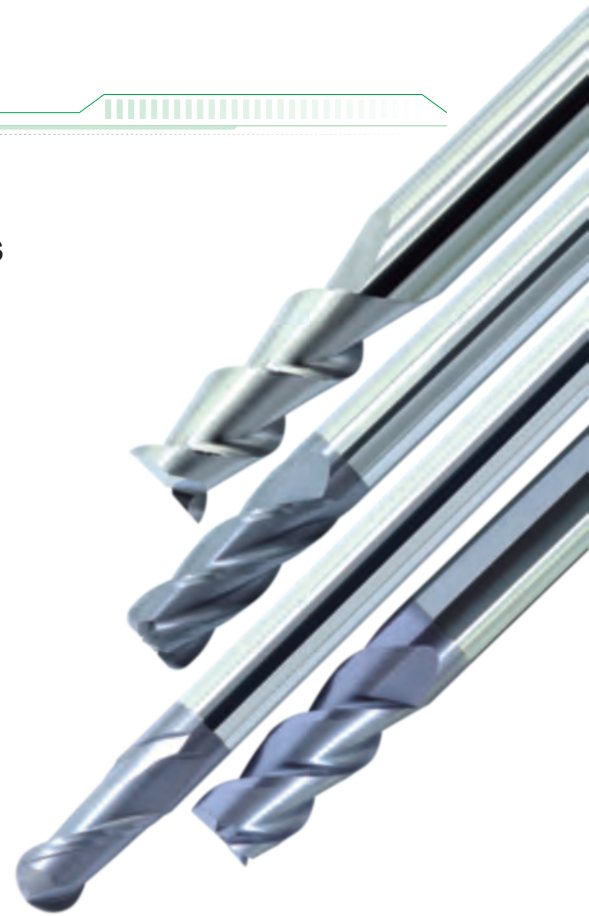

# GM

## series general end mills

**Wide application** High efficiency machining can be achieved ranging from common steel to pre-hardened steel machining.

**Optimized structure** Appropriate combination of sharp cutting edge and tool strength makes cutting easier and faster, extending tool life.

**Versatile product series** Suitable for rough machining with high metal removal rate to finish machining with high surface quality.

**Complete diameter range** Minimum diameter of 0.012in for machining of the smallest parts.

Tool type: GM-4E-D3/8"  
 Workpiece material: NAK80(40HRC)  
 cutting speed: 320SFPM  
 Feed per revolution: 0.008in/r  
 Axial cutting depth:  $a_p=0.591$ in  
 Radial cutting depth:  $a_e=0.039$ in  
 Cutting style: side milling (down milling)  
 Cooling system: air blow  
 Machine tool: MIKRON UCP 1000

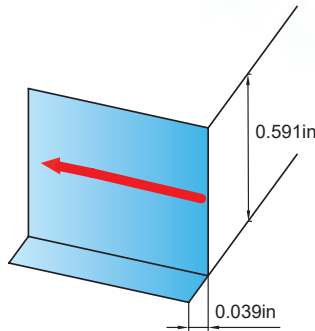

### Cutting edge abrasion and workpiece surface quality

End mill	GM-4E-D3/8"	Similar product of company A	Similar product of company B
Cutting length	2.36in	0.787in	2.36in

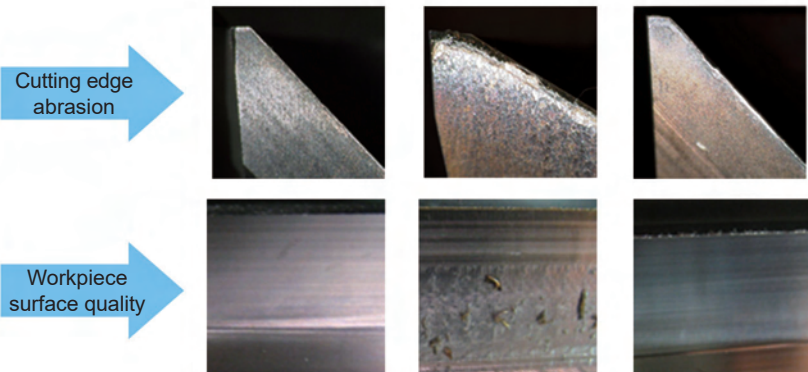



### 2-flute flattened end mills with straight shank

#### GM-2E

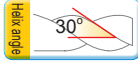
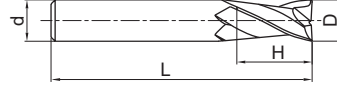

Art.No.	Specification				
	D	d	H	L	Z (Number of teeth)
GM-2E-1/32"	1/32"	1/8"	5/64"	1-1/2"	2
GM-2E-3/64"	3/64"	1/8"	7/64"	1-1/2"	2
GM-2E-1/16"	1/16"	1/8"	3/16"	1-1/2"	2
GM-2E-5/64"	5/64"	1/8"	3/16"	1-1/2"	2
GM-2E-3/32"	3/32"	1/8"	9/32"	1-1/2"	2
GM-2E-7/64"	7/64"	1/8"	3/8"	1-1/2"	2
GM-2E-1/8"	1/8"	1/8"	1/2"	1-1/2"	2
GM-2E-9/64"	9/64"	3/16"	1/2"	2"	2
GM-2E-5/32"	5/32"	3/16"	1/2"	2"	2
GM-2E-11/64"	11/64"	3/16"	5/8"	2"	2
GM-2E-3/16"	3/16"	3/16"	5/8"	2"	2
GM-2E-13/64"	13/64"	1/4"	5/8"	2-1/2"	2
GM-2E-7/32"	7/32"	1/4"	5/8"	2-1/2"	2
GM-2E-15/64"	15/64"	1/4"	3/4"	2-1/2"	2
GM-2E-1/4"	1/4"	1/4"	3/4"	2-1/2"	2
GM-2E-17/64"	17/64"	5/16"	3/4"	2-1/2"	2
GM-2E-9/32"	9/32"	5/16"	3/4"	2-1/2"	2
GM-2E-19/64"	19/64"	5/16"	13/16"	2-1/2"	2
GM-2E-5/16"	5/16"	5/16"	13/16"	2-1/2"	2

Art.No.	Specification				
	D	d	H	L	Z (Number of teeth)
GM-2E-21/64"	21/64"	3/8"	1"	2-1/2"	2
GM-2E-11/32"	11/32"	3/8"	1"	2-1/2"	2
GM-2E-23/64"	23/64"	3/8"	1"	2-1/2"	2
GM-2E-3/8"	3/8"	3/8"	1"	2-1/2"	2
GM-2E-25/64"	25/64"	7/16"	1"	2-3/4"	2
GM-2E-13/32"	13/32"	7/16"	1"	2-3/4"	2
GM-2E-27/64"	27/64"	7/16"	1"	2-3/4"	2
GM-2E-7/16"	7/16"	7/16"	1"	2-3/4"	2
GM-2E-29/64"	29/64"	1/2"	1"	3"	2
GM-2E-15/32"	15/32"	1/2"	1"	3"	2
GM-2E-31/64"	31/64"	1/2"	1"	3"	2
GM-2E-1/2"	1/2"	1/2"	1"	3"	2
GM-2E-9/16"	9/16"	9/16"	1-1/8"	3-1/2"	2
GM-2E-5/8"	5/8"	5/8"	1-1/4"	3-1/2"	2
GM-2E-11/16"	11/16"	3/4"	1-3/8"	4"	2
GM-2E-3/4"	3/4"	3/4"	1-1/2"	4"	2
GM-2E-7/8"	7/8"	7/8"	1-1/2"	4"	2
GM-2E-1"	1"	1"	1-1/2"	4"	2

### 2-flute flattened long cutting edge end mills with straight shank

#### GM-2EL

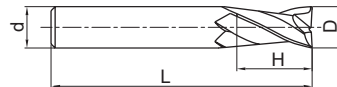

Art.No.	Specification				
	D	d	H	L	Z (Number of teeth)
GM-2EL-1/8"	1/8"	1/8"	3/4"	2-1/4"	2
GM-2EL-3/16"	3/16"	3/16"	3/4"	2-1/2"	2
GM-2EL-1/4"	1/4"	1/4"	1-1/8"	3"	2
GM-2EL-5/16"	5/16"	5/16"	1-1/8"	3"	2
GM-2EL-3/8"	3/8"	3/8"	1-1/8"	3"	2

Art.No.	Specification				
	D	d	H	L	Z (Number of teeth)
GM-2EL-7/16"	7/16"	7/16"	2"	4-1/2"	2
GM-2EL-1/2"	1/2"	1/2"	2"	4-1/2"	2
GM-2EL-5/8"	5/8"	5/8"	2-1/4"	5"	2
GM-2EL-3/4"	3/4"	3/4"	2-1/4"	5"	2
GM-2EL-1"	1"	1"	2-1/4"	5"	2

### 3-flute flattened end mills with straight shank

#### GM-3E

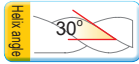
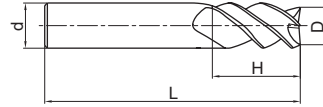

Art.No.	Specification				
	D	d	H	L	Z (Number of teeth)
GM-3E-3/64"	3/64"	1/8"	7/64"	1-1/2"	3
GM-3E-1/16"	1/16"	1/8"	3/16"	1-1/2"	3
GM-3E-5/64"	5/64"	1/8"	3/16"	1-1/2"	3
GM-3E-3/32"	3/32"	1/8"	9/32"	1-1/2"	3
GM-3E-7/64"	7/64"	1/8"	3/8"	1-1/2"	3
GM-3E-1/8"	1/8"	1/8"	1/2"	1-1/2"	3
GM-3E-9/64"	9/64"	3/16"	1/2"	2"	3
GM-3E-5/32"	5/32"	3/16"	1/2"	2"	3
GM-3E-11/64"	11/64"	3/16"	5/8"	2"	3
GM-3E-3/16"	3/16"	3/16"	5/8"	2"	3
GM-3E-13/64"	13/64"	1/4"	5/8"	2-1/2"	3
GM-3E-7/32"	7/32"	1/4"	5/6"	2-1/2"	3
GM-3E-15/64"	15/64"	1/4"	3/4"	2-1/2"	3
GM-3E-1/4"	1/4"	1/4"	3/4"	2-1/2"	3
GM-3E-17/64"	17/64"	5/16"	3/4"	2-1/2"	3
GM-3E-9/32"	9/32"	5/16"	3/4"	2-1/2"	3
GM-3E-19/64"	19/64"	5/16"	13/16"	2-1/2"	3
GM-3E-5/16"	5/16"	5/16"	13/16"	2-1/2"	3

Art.No.	Specification				
	D	d	H	L	Z (Number of teeth)
GM-3E-21/64"	21/64"	3/8"	1"	2-1/2"	3
GM-3E-11/32"	11/32"	3/8"	1"	2-1/2"	3
GM-3E-23/64"	23/64"	3/8"	1"	2-1/2"	3
GM-3E-3/8"	3/8"	3/8"	1"	2-1/2"	3
GM-3E-25/64"	25/64"	7/16"	1"	2-3/4"	3
GM-3E-13/32"	13/32"	7/16"	1"	2-3/4"	3
GM-3E-27/64"	27/64"	7/16"	1"	2-3/4"	3
GM-3E-7/16"	7/16"	7/16"	1"	2-3/4"	3
GM-3E-29/64"	29/64"	1/2"	1"	3"	3
GM-3E-15/32"	15/32"	1/2"	1"	3"	3
GM-3E-31/64"	31/64"	1/2"	1"	3"	3
GM-3E-1/2"	1/2"	1/2"	1"	3"	3
GM-3E-9/16"	9/16"	9/16"	1-1/8"	3-1/2"	3
GM-3E-5/8"	5/8"	5/8"	1-1/4"	3-1/2"	3
GM-3E-11/16"	11/16"	3/4"	1-3/8"	4"	3
GM-3E-3/4"	3/4"	3/4"	1-1/2"	4"	3
GM-3E-7/8"	7/8"	7/8"	1-1/2"	4"	3
GM-3E-1"	1"	1"	1-1/2"	4"	3

### 3-flute flattened long cutting edge end mills with straight shank

#### GM-3EL

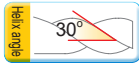
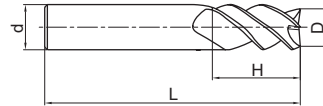

Art.No.	Specification				
	D	d	H	L	Z (Number of teeth)
GM-3EL-1/8"	1/8"	1/8"	3/4"	2-1/4"	3
GM-3EL-3/16"	3/16"	3/16"	3/4"	2-1/2"	3
GM-3EL-1/4"	1/4"	1/4"	1-1/8"	3"	3
GM-3EL-5/16"	5/16"	5/16"	1-1/8"	3"	3
GM-3EL-3/8"	3/8"	3/8"	1-1/8"	3"	3

Art.No.	Specification				
	D	d	H	L	Z (Number of teeth)
GM-3EL-7/16"	7/16"	7/16"	2"	4-1/2"	3
GM-3EL-1/2"	1/2"	1/2"	2"	4-1/2"	3
GM-3EL-5/8"	5/8"	5/8"	2-1/4"	5"	3
GM-3EL-3/4"	3/4"	3/4"	2-1/4"	5"	3
GM-3EL-1"	1"	1"	2-1/4"	5"	3

### 4-flute flattened end mills with straight shank

#### GM-4E

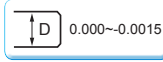
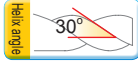
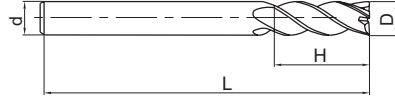

Art.No.	Specification				
	D	d	H	L	Z (Number of teeth)
GM-4E-3/64"	3/64"	1/8"	7/64"	1-1/2"	4
GM-4E-1/16"	1/16"	1/8"	3/16"	1-1/2"	4
GM-4E-5/64"	5/64"	1/8"	3/16"	1-1/2"	4
GM-4E-3/32"	3/32"	1/8"	9/32"	1-1/2"	4
GM-4E-7/64"	7/64"	1/8"	3/8"	1-1/2"	4
GM-4E-1/8"	1/8"	1/8"	1/2"	1-1/2"	4
GM-4E-9/64"	9/64"	3/16"	1/2"	2"	4
GM-4E-5/32"	5/32"	3/16"	1/2"	2"	4
GM-4E-11/64"	11/64"	3/16"	5/8"	2"	4
GM-4E-3/16"	3/16"	3/16"	5/8"	2"	4
GM-4E-13/64"	13/64"	1/4"	5/8"	2-1/2"	4
GM-4E-7/32"	7/32"	1/4"	5/8"	2-1/2"	4
GM-4E-15/64"	15/64"	1/4"	3/4"	2-1/2"	4
GM-4E-1/4"	1/4"	1/4"	3/4"	2-1/2"	4
GM-4E-17/64"	17/64"	5/16"	3/4"	2-1/2"	4
GM-4E-9/32"	9/32"	5/16"	3/4"	2-1/2"	4
GM-4E-19/64"	19/64"	5/16"	13/16"	2-1/2"	4
GM-4E-5/16"	5/16"	5/16"	13/16"	2-1/2"	4

Art.No.	Specification				
	D	d	H	L	Z (Number of teeth)
GM-4E-21/64"	21/64"	3/8"	1"	2-1/2"	4
GM-4E-11/32"	11/32"	3/8"	1"	2-1/2"	4
GM-4E-23/64"	23/64"	3/8"	1"	2-1/2"	4
GM-4E-3/8"	3/8"	3/8"	1"	2-1/2"	4
GM-4E-25/64"	25/64"	7/16"	1"	2-3/4"	4
GM-4E-13/32"	13/32"	7/16"	1"	2-3/4"	4
GM-4E-27/64"	27/64"	7/16"	1"	2-3/4"	4
GM-4E-7/16"	7/16"	7/16"	1"	2-3/4"	4
GM-4E-29/64"	29/64"	1/2"	1"	3"	4
GM-4E-15/32"	15/32"	1/2"	1"	3"	4
GM-4E-31/64"	31/64"	1/2"	1"	3"	4
GM-4E-1/2"	1/2"	1/2"	1-1/8"	3"	4
GM-4E-9/16"	9/16"	9/16"	1-1/8"	3-1/2"	4
GM-4E-5/8"	5/8"	5/8"	1-1/4"	3-1/2"	4
GM-4E-11/16"	11/16"	3/4"	1-3/8"	4"	4
GM-4E-3/4"	3/4"	3/4"	1-5/8"	4"	4
GM-4E-7/8"	7/8"	7/8"	1-5/8"	4"	4
GM-4E-1"	1"	1"	1-5/8"	4"	4

### 4-flute flattened long cutting edge end mills with straight shank

#### GM-4EL

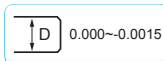
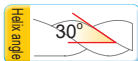
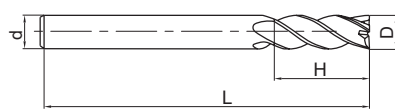

Art.No.	Specification				
	D	d	H	L	Z (Number of teeth)
GM-4EL-1/8"	1/8"	1/8"	3/4"	2-1/4"	4
GM-4EL-3/16"	3/16"	3/16"	3/4"	2-1/2"	4
GM-4EL-1/4"	1/4"	1/4"	1-1/2"	3"	4
GM-4EL-5/16"	5/16"	5/16"	1-1/2"	3"	4
GM-4EL-3/8"	3/8"	3/8"	1-1/2"	3"	4

Art.No.	Specification				
	D	d	H	L	Z (Number of teeth)
GM-4EL-7/16"	7/16"	7/16"	2-1/8"	4-1/2"	4
GM-4EL-1/2"	1/2"	1/2"	2-1/8"	4-1/2"	4
GM-4EL-5/8"	5/8"	5/8"	2-1/2"	5"	4
GM-4EL-3/4"	3/4"	3/4"	2-1/2"	5"	4
GM-4EL-1"	1"	1"	2-1/2"	5"	4

### 4-flute flattened end mills with straight shank

#### GM-4E-S

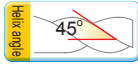
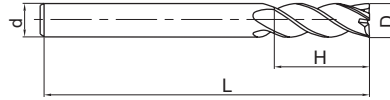

Art.No.	Specification				
	D	d	H	L	Z (Number of teeth)
GM-4E-3/64"-S	3/64"	1/8"	7/64"	1-1/2"	4
GM-4E-1/16"-S	1/16"	1/8"	3/16"	1-1/2"	4
GM-4E-5/64"-S	5/64"	1/8"	3/16"	1-1/2"	4
GM-4E-3/32"-S	3/32"	1/8"	9/32"	1-1/2"	4
GM-4E-7/64"-S	7/64"	1/8"	3/8"	1-1/2"	4
GM-4E-1/8"-S	1/8"	1/8"	1/2"	1-1/2"	4
GM-4E-9/64"-S	9/64"	3/16"	1/2"	2"	4
GM-4E-5/32"-S	5/32"	3/16"	1/2"	2"	4
GM-4E-11/64"-S	11/64"	3/16"	5/8"	2"	4
GM-4E-3/16"-S	3/16"	3/16"	5/8"	2"	4
GM-4E-13/64"-S	13/64"	1/4"	5/8"	2-1/2"	4
GM-4E-7/32"-S	7/32"	1/4"	5/8"	2-1/2"	4
GM-4E-15/64"-S	15/64"	1/4"	3/4"	2-1/2"	4
GM-4E-1/4"-S	1/4"	1/4"	3/4"	2-1/2"	4
GM-4E-17/64"-S	17/64"	5/16"	3/4"	2-1/2"	4
GM-4E-9/32"-S	9/32"	5/16"	3/4"	2-1/2"	4
GM-4E-19/64"-S	19/64"	5/16"	13/16"	2-1/2"	4
GM-4E-5/16"-S	5/16"	5/16"	13/16"	2-1/2"	4

Art.No.	Specification				
	D	d	H	L	Z (Number of teeth)
GM-4E-21/64"-S	21/64"	3/8"	1"	2-1/2"	4
GM-4E-11/32"-S	11/32"	3/8"	1"	2-1/2"	4
GM-4E-23/64"-S	23/64"	3/8"	1"	2-1/2"	4
GM-4E-3/8"-S	3/8"	3/8"	1"	2-1/2"	4
GM-4E-25/64"-S	25/64"	7/16"	1"	2-3/4"	4
GM-4E-13/32"-S	13/32"	7/16"	1"	2-3/4"	4
GM-4E-27/64"-S	27/64"	7/16"	1"	2-3/4"	4
GM-4E-7/16"-S	7/16"	7/16"	1"	2-3/4"	4
GM-4E-29/64"-S	29/64"	1/2"	1"	3"	4
GM-4E-15/32"-S	15/32"	1/2"	1"	3"	4
GM-4E-31/64"-S	31/64"	1/2"	1"	3"	4
GM-4E-1/2"-S	1/2"	1/2"	1"	3"	4
GM-4E-9/16"-S	9/16"	9/16"	1-1/8"	3-1/2"	4
GM-4E-5/8"-S	5/8"	5/8"	1-1/4"	3-1/2"	4
GM-4E-11/16"-S	11/16"	3/4"	1-3/8"	4"	4
GM-4E-3/4"-S	3/4"	3/4"	1-1/2"	4"	4
GM-4E-7/8"-S	7/8"	7/8"	1-1/2"	4"	4
GM-4E-1"-S	1"	1"	1-1/2"	4"	4

### 4-flute flattened long cutting edge end mills with straight shank

#### GM-4EL-S

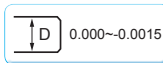
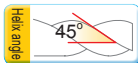
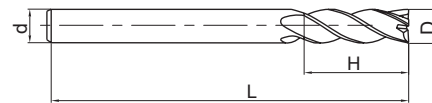

Art.No.	Specification				
	D	d	H	L	Z (Number of teeth)
GM-4EL-1/8"-S	1/8"	1/8"	3/4"	2-1/4"	4
GM-4EL-3/16"-S	3/16"	3/16"	3/4"	2-1/2"	4
GM-4EL-1/4"-S	1/4"	1/4"	1-1/8"	3"	4
GM-4EL-5/16"-S	5/16"	5/16"	1-1/8"	3"	4
GM-4EL-3/8"-S	3/8"	3/8"	1-1/8"	3"	4

Art.No.	Specification				
	D	d	H	L	Z (Number of teeth)
GM-4EL-7/16"-S	7/16"	7/16"	2"	4-1/2"	4
GM-4EL-1/2"-S	1/2"	1/2"	2"	4-1/2"	4
GM-4EL-5/8"-S	5/8"	5/8"	2-1/4"	5"	4
GM-4EL-3/4"-S	3/4"	3/4"	2-1/4"	5"	4
GM-4EL-1"-S	1"	1"	2-1/4"	5"	4

GM-4E/EL-1/8"-S

45° degree helical angle

### 2-flute ball nose end mills with straight shank

#### GM-2B

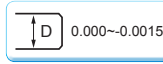
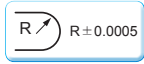
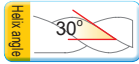
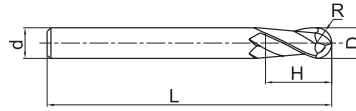

Art.No.	Specification				
	D	d	H	L	Z (Number of teeth)
GM-2B-1/32"	1/32"	1/8"	5/64"	1-1/2"	2
GM-2B-3/64"	3/64"	1/8"	7/64"	1-1/2"	2
GM-2B-1/16"	1/16"	1/8"	3/16"	1-1/2"	2
GM-2B-5/64"	5/64"	1/8"	3/16"	1-1/2"	2
GM-2B-3/32"	3/32"	1/8"	9/32"	1-1/2"	2
GM-2B-7/64"	7/64"	1/8"	3/8"	1-1/2"	2
GM-2B-1/8"	1/8"	1/8"	1/2"	1-1/2"	2
GM-2B-9/64"	9/64"	3/16"	1/2"	2"	2
GM-2B-5/32"	5/32"	3/16"	1/2"	2"	2
GM-2B-11/64"	11/64"	3/16"	5/8"	2"	2
GM-2B-3/16"	3/16"	3/16"	5/8"	2"	2
GM-2B-13/64"	13/64"	1/4"	5/8"	2-1/2"	2
GM-2B-7/32"	7/32"	1/4"	5/8"	2-1/2"	2
GM-2B-15/64"	15/64"	1/4"	3/4"	2-1/2"	2
GM-2B-1/4"	1/4"	1/4"	3/4"	2-1/2"	2
GM-2B-17/64"	17/64"	5/16"	3/4"	2-1/2"	2
GM-2B-9/32"	9/32"	5/16"	3/4"	2-1/2"	2
GM-2B-19/64"	19/64"	5/16"	13/16"	2-1/2"	2
GM-2B-5/16"	5/16"	5/16"	13/16"	2-1/2"	2

Art.No.	Specification				
	D	d	H	L	Z (Number of teeth)
GM-2B-21/64"	21/64"	3/8"	1"	2-1/2"	2
GM-2B-11/32"	11/32"	3/8"	1"	2-1/2"	2
GM-2B-23/64"	23/64"	3/8"	1"	2-1/2"	2
GM-2B-3/8"	3/8"	3/8"	1"	2-1/2"	2
GM-2B-25/64"	25/64"	7/16"	1"	2-3/4"	2
GM-2B-13/32"	13/32"	7/16"	1"	2-3/4"	2
GM-2B-27/64"	27/64"	7/16"	1"	2-3/4"	2
GM-2B-7/16"	7/16"	7/16"	1"	2-3/4"	2
GM-2B-29/64"	29/64"	1/2"	1"	3"	2
GM-2B-15/32"	15/32"	1/2"	1"	3"	2
GM-2B-31/64"	31/64"	1/2"	1"	3"	2
GM-2B-1/2"	1/2"	1/2"	1"	3"	2
GM-2B-9/16"	9/16"	9/16"	1-1/8"	3-1/2"	2
GM-2B-5/8"	5/8"	5/8"	1-1/4"	3-1/2"	2
GM-2B-11/16"	11/16"	3/4"	1-3/8"	4"	2
GM-2B-3/4"	3/4"	3/4"	1-1/2"	4"	2
GM-2B-7/8"	7/8"	7/8"	1-1/2"	4"	2
GM-2B-1"	1"	1"	1-1/2"	4"	2

### 2-flute ball nose end mills with long straight shank

#### GM-2BL

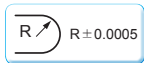
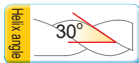

Art.No.	Specification				
	D	d	H	L	Z (Number of teeth)
GM-2BL-1/8"	1/8"	1/8"	3/4"	2-1/4"	2
GM-2BL-3/16"	3/16"	3/16"	3/4"	2-1/2"	2
GM-2BL-1/4"	1/4"	1/4"	1-1/8"	3"	2
GM-2BL-5/16"	5/16"	5/16"	1-1/8"	3"	2
GM-2BL-3/8"	3/8"	3/8"	1-1/8"	3"	2

Art.No.	Specification				
	D	d	H	L	Z (Number of teeth)
GM-2BL-7/16"	7/16"	7/16"	2"	4-1/2"	2
GM-2BL-1/2"	1/2"	1/2"	2"	4-1/2"	2
GM-2BL-5/8"	5/8"	5/8"	2-1/4"	5"	2
GM-2BL-3/4"	3/4"	3/4"	2-1/4"	5"	2
GM-2BL-1"	1"	1"	2-1/4"	5"	2

### 4-flute ball nose end mills with straight shank

#### GM-4B

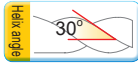
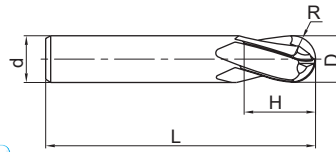

Art.No.	Specification				
	D	d	H	L	Z (Number of teeth)
GM-4B-1/8"	1/8"	1/8"	1/2"	1-1/2"	4
GM-4B-9/64"	9/64"	3/16"	1/2"	2"	4
GM-4B-5/32"	5/32"	3/16"	1/2"	2"	4
GM4B-11/64"	11/64"	3/16"	5/8"	2"	4
GM-4B-3/16"	3/16"	3/16"	5/8"	2"	4
GM-4B-13/64"	13/64"	1/4"	5/8"	2-1/2"	4
GM-4B-7/32"	7/32"	1/4"	5/8"	2-1/2"	4
GM-4B-15/64"	15/64"	1/4"	3/4"	2-1/2"	4
GM-4B-1/4"	1/4"	1/4"	3/4"	2-1/2"	4
GM-4B-17/64"	17/64"	5/16"	3/4"	2-1/2"	4
GM-4B-9/32"	9/32"	5/16"	3/4"	2-1/2"	4
GM4B-19/64"	19/64"	5/16"	13/16"	2-1/2"	4
GM-4B-5/16"	5/16"	5/16"	13/16"	2-1/2"	4
GM-4B-21/64"	21/64"	3/8"	1"	2-1/2"	4
GM-4B-11/32"	11/32"	3/8"	1"	2-1/2"	4
GM-4B-23/64"	23/64"	3/8"	1"	2-1/2"	4

Art.No.	Specification				
	D	d	H	L	Z (Number of teeth)
GM-4B-3/8"	3/8"	3/8"	1"	2-1/2"	4
GM-4B-25/64"	25/64"	7/16"	1"	2-3/4"	4
GM-4B-13/32"	13/32"	7/16"	1"	2-3/4"	4
GM-4B-27/64"	27/64"	7/16"	1"	2-3/4"	4
GM-4B-7/16"	7/16"	7/16"	1"	2-3/4"	4
GM-4B-29/64"	29/64"	1/2"	1"	3"	4
GM-4B-15/32"	15/32"	1/2"	1"	3"	4
GM-4B-31/64"	31/64"	1/2"	1"	3"	4
GM-4B-1/2"	1/2"	1/2"	1"	3"	4
GM-4B-9/16"	9/16"	9/16"	1-1/8"	3-1/2"	4
GM-4B-5/8"	5/8"	5/8"	1-1/4"	3-1/2"	4
GM-4B-11/16"	11/16"	3/4"	1-3/8"	4"	4
GM-4B-3/4"	3/4"	3/4"	1-1/2"	4"	4
GM-4B-7/8"	7/8"	7/8"	1-1/2"	4"	4
GM-4B-1"	1"	1"	1-1/2"	4"	4

### 4-flute ball nose end mills with long straight shank

#### GM-4BL

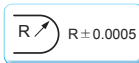
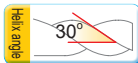
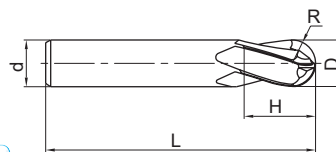

Art.No.	Specification				
	D	d	H	L	Z (Number of teeth)
GM-4BL-1/8"	1/8"	1/8"	3/4"	2-1/4"	4
GM-4BL-3/16"	3/16"	3/16"	3/4"	2-1/2"	4
GM-4BL-1/4"	1/4"	1/4"	1-1/8"	3"	4
GM-4BL-5/16"	5/16"	5/16"	1-1/8"	3"	4
GM-4BL-3/8"	3/8"	3/8"	1-1/8"	3"	4

Art.No.	Specification				
	D	d	H	L	Z (Number of teeth)
GM-4BL-7/16"	7/16"	7/16"	2"	4-1/2"	4
GM-4BL-1/2"	1/2"	1/2"	2"	4-1/2"	4
GM-4BL-5/8"	5/8"	5/8"	2-1/4"	5"	4
GM-4BL-3/4"	3/4"	3/4"	2-1/4"	5"	4
GM-4BL-1"	1"	1"	2-1/4"	5"	4

### 2-flute flattened end mills with straight shank and tiny diameter

#### GM-2ES



Art.No.	Specification				
	D	d	H	L	Z (Number of teeth)
GM-2ES-0.012"	0.012"	1/8"	0.018"	1-1/2"	2
GM-2ES-0.013"	0.013"	1/8"	0.020"	1-1/2"	2
GM-2ES-0.014"	0.014"	1/8"	0.021"	1-1/2"	2
GM-2ES-0.015"	0.015"	1/8"	0.023"	1-1/2"	2
GM-2ES-0.016"	0.016"	1/8"	0.024"	1-1/2"	2
GM-2ES-0.017"	0.017"	1/8"	0.026"	1-1/2"	2
GM-2ES-0.018"	0.018"	1/8"	0.027"	1-1/2"	2
GM-2ES-0.019"	0.019"	1/8"	0.029"	1-1/2"	2
GM-2ES-0.020"	0.020"	1/8"	0.030"	1-1/2"	2
GM-2ES-0.021"	0.021"	1/8"	0.032"	1-1/2"	2
GM-2ES-0.022"	0.022"	1/8"	0.033"	1-1/2"	2
GM-2ES-0.023"	0.023"	1/8"	0.035"	1-1/2"	2
GM-2ES-0.024"	0.024"	1/8"	0.036"	1-1/2"	2

Art.No.	Specification				
	D	d	H	L	Z (Number of teeth)
GM-2ES-0.025"	0.025"	1/8"	0.038"	1-1/2"	2
GM-2ES-0.026"	0.026"	1/8"	0.039"	1-1/2"	2
GM-2ES-0.027"	0.027"	1/8"	0.041"	1-1/2"	2
GM-2ES-0.028"	0.028"	1/8"	0.042"	1-1/2"	2
GM-2ES-0.029"	0.029"	1/8"	0.044"	1-1/2"	2
GM-2ES-0.030"	0.030"	1/8"	0.045"	1-1/2"	2
GM-2ES-0.031"	0.031"	1/8"	0.047"	1-1/2"	2
GM-2ES-0.035"	0.035"	1/8"	0.053"	1-1/2"	2
GM-2ES-0.040"	0.040"	1/8"	0.060"	1-1/2"	2
GM-2ES-0.047"	0.047"	1/8"	0.071"	1-1/2"	2
GM-2ES-0.050"	0.050"	1/8"	0.075"	1-1/2"	2
GM-2ES-0.055"	0.055"	1/8"	0.083"	1-1/2"	2
GM-2ES-0.060"	0.060"	1/8"	0.090"	1-1/2"	2

### 2-flute R end mills with straight shank

#### GM-2R



Art.No.	Specification					
	D	R	d	H	L (Number of teeth)	
GM-2R-1/8"R015	1/8"	0.015"	1/8"	1/2"	1-1/2"	2
GM-2R-1/8"R020	1/8"	0.020"	1/8"	1/2"	1-1/2"	2
GM-2R-3/16"R015	3/16"	0.015"	3/16"	5/8"	2"	2
GM-2R-3/16"R020	3/16"	0.020"	3/16"	5/8"	2"	2
GM-2R-3/16"R030	3/16"	0.030"	3/16"	5/8"	2"	2
GM-2R-1/4"R015	1/4"	0.015"	1/4"	3/4"	2-1/2"	2
GM-2R-1/4"R020	1/4"	0.020"	1/4"	3/4"	2-1/2"	2
GM-2R-1/4"R030	1/4"	0.030"	1/4"	3/4"	2-1/2"	2
GM-2R-1/4"R045	1/4"	0.045"	1/4"	3/4"	2-1/2"	2
GM-2R-5/16"R015	5/16"	0.015"	5/16"	13/16"	2-1/2"	2
GM-2R-5/16"R020	5/16"	0.020"	5/16"	13/16"	2-1/2"	2

Art.No.	Specification					
	D	R	d	H	L (Number of teeth)	
GM-2R-5/16"R030	5/16"	0.030"	5/16"	13/16"	2-1/2"	2
GM-2R-5/16"R045	5/16"	0.045"	5/16"	13/16"	2-1/2"	2
GM-2R-3/8"R015	3/8"	0.015"	3/8"	1"	2-1/2"	2
GM-2R-3/8"R020	3/8"	0.020"	3/8"	1"	2-1/2"	2
GM-2R-3/8"R030	3/8"	0.030"	3/8"	1"	2-1/2"	2
GM-2R-3/8"R045	3/8"	0.045"	3/8"	1"	2-1/2"	2
GM-2R-1/2"R015	1/2"	0.015"	1/2"	1"	3"	2
GM-2R-1/2"R020	1/2"	0.020"	1/2"	1"	3"	2
GM-2R-1/2"R030	1/2"	0.030"	1/2"	1"	3"	2
GM-2R-1/2"R045	1/2"	0.045"	1/2"	1"	3"	2
GM-2R-1/2"R060	1/2"	0.060"	1/2"	1"	3"	2

### 4-flute R end mills with straight shank

#### GM-4R

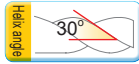
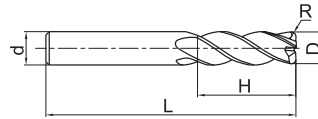

Art.No.	Specification					
	D	R	d	H	L	Z (Number of teeth)
GM-4R-1/8"R015	1/8"	0.015"	1/8"	1/2"	1-1/2"	4
GM-4R-1/8"R020	1/8"	0.020"	1/8"	1/2"	1-1/2"	4
GM-4R-3/16"R015	3/16"	0.015"	3/16"	5/8"	2"	4
GM-4R-3/16"R020	3/16"	0.020"	3/16"	5/8"	2"	4
GM-4R-3/16"R030	3/16"	0.030"	3/16"	5/8"	2"	4
GM-4R-1/4"R015	1/4"	0.015"	1/4"	3/4"	2-1/2"	4
GM-4R-1/4"R020	1/4"	0.020"	1/4"	3/4"	2-1/2"	4
GM-4R-1/4"R030	1/4"	0.030"	1/4"	3/4"	2-1/2"	4
GM-4R-1/4"R045	1/4"	0.045"	1/4"	3/4"	2-1/2"	4
GM-4R-5/16"R015	5/16"	0.015"	5/16"	13/16"	2-1/2"	4
GM-4R-5/16"R020	5/16"	0.020"	5/16"	13/16"	2-1/2"	4

Art.No.	Specification					
	D	R	d	H	L	Z (Number of teeth)
GM-4R-5/16"R030	5/16"	0.030"	5/16"	13/16"	2-1/2"	4
GM-4R-5/16"R045	5/16"	0.045"	5/16"	13/16"	2-1/2"	4
GM-4R-3/8"R015	3/8"	0.015"	3/8"	1"	2-1/2"	4
GM-4R-3/8"R020	3/8"	0.020"	3/8"	1"	2-1/2"	4
GM-4R-3/8"R030	3/8"	0.030"	3/8"	1"	2-1/2"	4
GM-4R-3/8"R045	3/8"	0.045"	3/8"	1"	2-1/2"	4
GM-4R-1/2"R015	1/2"	0.015"	1/2"	1"	3"	4
GM-4R-1/2"R020	1/2"	0.020"	1/2"	1"	3"	4
GM-4R-1/2"R030	1/2"	0.030"	1/2"	1"	3"	4
GM-4R-1/2"R045	1/2"	0.045"	1/2"	1"	3"	4
GM-4R-1/2"R060	1/2"	0.060"	1/2"	1"	3"	4

### 4-flute flattened end mills with straight shank and corrugated edges

#### GM-4W

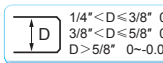
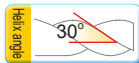
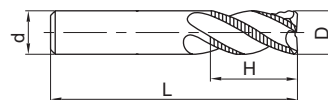
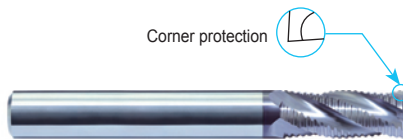

Art.No.	Specification				
	D	d	H	L	Z (Number of teeth)
GM-4W-1/4"	1/4"	1/4"	3/4"	2-1/2"	4
GM-4W-3/8"	3/8"	3/8"	1"	2-1/2"	4
GM-4W-1/2"	1/2"	1/2"	1-1/4"	3"	4

Art.No.	Specification				
	D	d	H	L	Z (Number of teeth)
GM-4W-5/8"	5/8"	5/8"	1-1/2"	3-1/2"	4
GM-4W-3/4"	3/4"	3/4"	1-3/4"	4"	4





# HMX series

## end mills for high-hardness steel machining

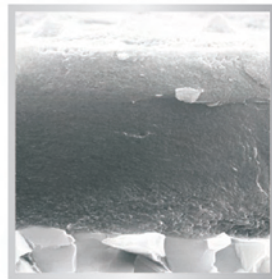

Lattice heterogeneous coating

Lattice heterogeneous coating added with special elements, with high hardness and excellent high temperature oxidation resistance, more suitable for high hardness materials and high speed machining

Excellent coating processing technology, more closely combined with substrate

- Unique cutter structure, properly designed chipbreaker, for outstanding cutting performance.
- Orange red coating allows for better wear observation.
- Special after treatment greatly reduces friction, for smoother chip evacuation and superior surface quality.

New technology  
Breakthrough upgrading

### Perfect high temperature oxidation resistance:

After oxidation at 1100 ° C, HMX series cutter coating only has a very thin oxide layer, while the similar products of Company A has completely oxidized.

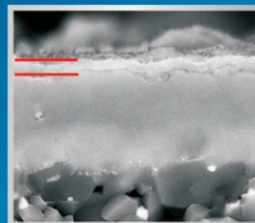

HMX series

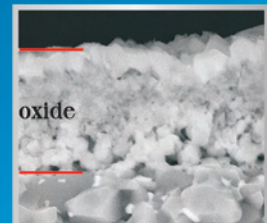

A company

# HMX series end mills for high-hardness steel machining



## Longer tool life

### tool: HMX-4E-1/16"

workpiece material: SKD11(62HRC)  
 cutting speed: 320SFPM  
 feed per tooth: 0.0079in/r  
 axial depth of cut:  $a_p=0.3937$ in  
 radial depth of cut:  $a_e=0.0118$ in  
 cooling system: air cooling



wear comparison after machining 60min

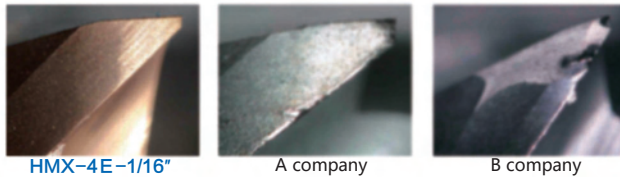

peripheral edges wear curves

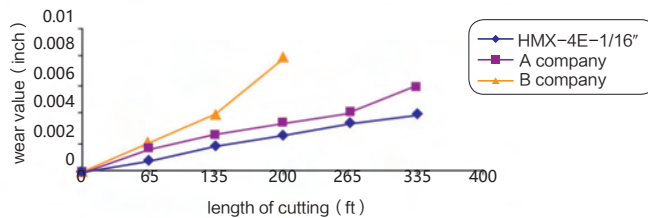

### tool: HMX-4EL-1/4"

milling method: end milling  
 workpiece material: D2 mod.  
 cutting speed: 320SFPM  
 feed per revolution: 0.0059in/r  
 depth of cut: 0.0118in  
 cutting width: 0.1969in  
 cooling system: air cooling

wear comparison after machining 40min

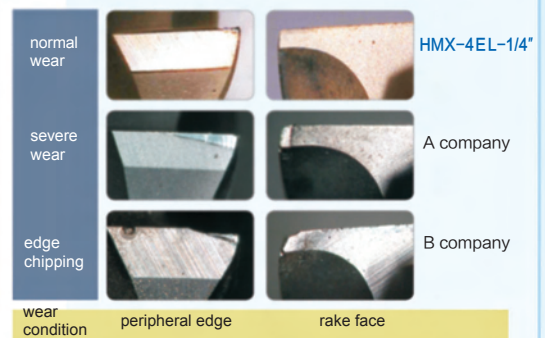

## high machining efficient

### tool: HMX-4E-1/4"

machining parts: cavity machining  
 (1.2in×1.2in×0.4in)  
 workpiece material: D2 mod.  
 cutting speed: 650SFPM  
 feed per revolution: 0.0079in/r  
 cutting width: 0.0118in  
 cutting depth: 0.1969in  
 cooling system: air cooling



time comparison for complete one cavity

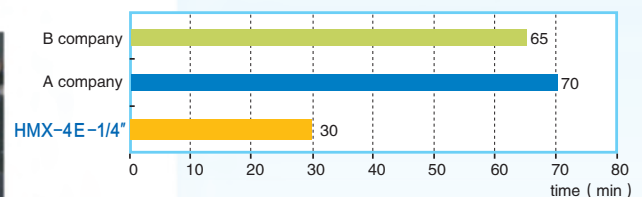

**100% Improvement of machining efficient on HMX than others!**

## Good machining quality

### tool: HMX-2B-1/4"

workpiece material: SKD11(HRC62)  
 cutting speed : 650SFPM  
 feed per revolution: 0.0079in/r  
 cutting width: 0.0079in  
 cutting depth: 0.0118in  
 cooling system: air cooling

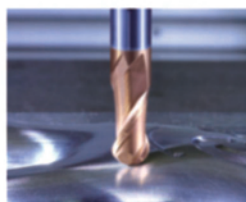

surface roughness curves of machined surface

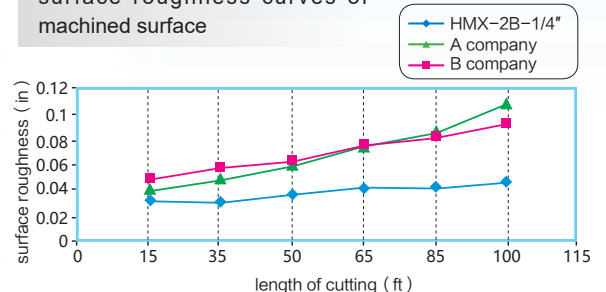

### 4-flute flattened end mills with straight shank

#### HMX-4E

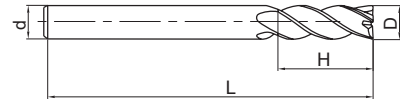

Art.No.	Specification				
	D	d	H	L	Z (Number of teeth)
HMX-4E-3/64"	3/64"	1/8"	7/64"	1-1/2"	4
HMX-4E-1/16"	1/16"	1/8"	3/16"	1-1/2"	4
HMX-4E-5/64"	5/64"	1/8"	3/16"	1-1/2"	4
HMX-4E-3/32"	3/32"	1/8"	9/32"	1-1/2"	4
HMX-4E-7/64"	7/64"	1/8"	3/8"	1-1/2"	4
HMX-4E-1/8"	1/8"	1/8"	1/2"	1-1/2"	4
HMX-4E-9/64"	9/64"	3/16"	1/2"	2"	4
HMX-4E-5/32"	5/32"	3/16"	1/2"	2"	4
HMX-4E-11/64"	11/64"	3/16"	5/8"	2"	4
HMX-4E-3/16"	3/16"	3/16"	5/8"	2"	4
HMX-4E-13/64"	13/64"	1/4"	5/8"	2-1/2"	4
HMX-4E-7/32"	7/32"	1/4"	5/8"	2-1/2"	4
HMX-4E-15/64"	15/64"	1/4"	3/4"	2-1/2"	4
HMX-4E-1/4"	1/4"	1/4"	3/4"	2-1/2"	4
HMX-4E-17/64"	17/64"	5/16"	3/4"	2-1/2"	4
HMX-4E-9/32"	9/32"	5/16"	3/4"	2-1/2"	4
HMX-4E-19/64"	19/64"	5/16"	13/16"	2-1/2"	4
HMX-4E-5/16"	5/16"	5/16"	13/16"	2-1/2"	4

Art.No.	Specification				
	D	d	H	L	Z (Number of teeth)
HMX-4E-21/64"	21/64"	3/8"	1"	2-1/2"	4
HMX-4E-11/32"	11/32"	3/8"	1"	2-1/2"	4
HMX-4E-23/64"	23/64"	3/8"	1"	2-1/2"	4
HMX-4E-3/8"	3/8"	3/8"	1"	2-1/2"	4
HMX-4E-25/64"	25/64"	7/16"	1"	2-3/4"	4
HMX-4E-13/32"	13/32"	7/16"	1"	2-3/4"	4
HMX-4E-27/64"	27/64"	7/16"	1"	2-3/4"	4
HMX-4E-7/16"	7/16"	7/16"	1"	2-3/4"	4
HMX-4E-29/64"	29/64"	1/2"	1"	3"	4
HMX-4E-15/32"	15/32"	1/2"	1"	3"	4
HMX-4E-31/64"	31/64"	1/2"	1"	3"	4
HMX-4E-1/2"	1/2"	1/2"	1-1/8"	3"	4
HMX-4E-9/16"	9/16"	9/16"	1-1/8"	3-1/2"	4
HMX-4E-5/8"	5/8"	5/8"	1-1/4"	3-1/2"	4
HMX-4E-11/16"	11/16"	3/4"	1-3/8"	4"	4
HMX-4E-3/4"	3/4"	3/4"	1-5/8"	4"	4
HMX-4E-7/8"	7/8"	7/8"	1-5/8"	4"	4
HMX-4E-1"	1"	1"	1-5/8"	4"	4

### 4-flute flattened long cutting edge end mills with straight shank

#### HMX-4EL

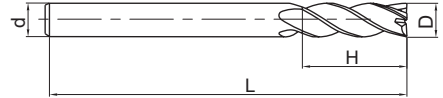
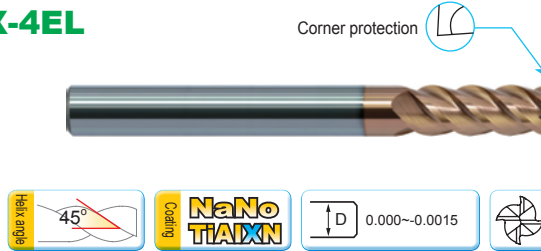

Art.No.	Specification				
	D	d	H	L	Z (Number of teeth)
HMX-4EL-1/8"	1/8"	1/8"	3/4"	2-1/4"	4
HMX-4EL-3/16"	3/16"	3/16"	3/4"	2-1/2"	4
HMX-4EL-1/4"	1/4"	1/4"	1-1/2"	3"	4
HMX-4EL-5/16"	5/16"	5/16"	1-1/2"	3"	4
HMX-4EL-3/8"	3/8"	3/8"	1-1/2"	3"	4

Art.No.	Specification				
	D	d	H	L	Z (Number of teeth)
HMX-4EL-7/16"	7/16"	7/16"	2-1/8"	4-1/2"	4
HMX-4EL-1/2"	1/2"	1/2"	2-1/8"	4-1/2"	4
HMX-4EL-5/8"	5/8"	5/8"	2-1/2"	5"	4
HMX-4EL-3/4"	3/4"	3/4"	2-1/2"	5"	4
HMX-4EL-1"	1"	1"	2-1/2"	5"	4

### 2-flute ball nose end mills with straight shank

#### HMX-2B

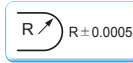
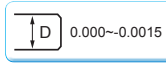
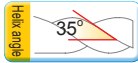
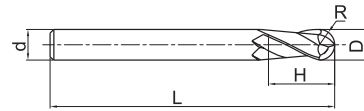

Art.No.	Specification				
	D	d	H	L	Z (Number of teeth)
HMX-2B-1/32"	1/32"	1/8"	5/64"	1-1/2"	2
HMX-2B-3/64"	3/64"	1/8"	7/64"	1-1/2"	2
HMX-2B-1/16"	1/16"	1/8"	3/16"	1-1/2"	2
HMX-2B-5/64"	5/64"	1/8"	3/16"	1-1/2"	2
HMX-2B-3/32"	3/32"	1/8"	9/32"	1-1/2"	2
HMX-2B-7/64"	7/64"	1/8"	3/8"	1-1/2"	2
HMX-2B-1/8"	1/8"	1/8"	1/2"	1-1/2"	2
HMX-2B-9/64"	9/64"	3/16"	1/2"	2"	2
HMX-2B-5/32"	5/32"	3/16"	1/2"	2"	2
HMX-2B-11/64"	11/64"	3/16"	5/8"	2"	2
HMX-2B-3/16"	3/16"	3/16"	5/8"	2"	2
HMX-2B-13/64"	13/64"	1/4"	5/8"	2-1/2"	2
HMX-2B-7/32"	7/32"	1/4"	5/8"	2-1/2"	2
HMX-2B-15/64"	15/64"	1/4"	3/4"	2-1/2"	2
HMX-2B-1/4"	1/4"	1/4"	3/4"	2-1/2"	2
HMX-2B-17/64"	17/64"	5/16"	3/4"	2-1/2"	2
HMX-2B-9/32"	9/32"	5/16"	3/4"	2-1/2"	2
HMX-2B-19/64"	19/64"	5/16"	13/16"	2-1/2"	2
HMX-2B-5/16"	5/16"	5/16"	13/16"	2-1/2"	2

Art.No.	Specification				
	D	d	H	L	Z (Number of teeth)
HMX-2B-21/64"	21/64"	3/8"	1"	2-1/2"	2
HMX-2B-11/32"	11/32"	3/8"	1"	2-1/2"	2
HMX-2B-23/64"	23/64"	3/8"	1"	2-1/2"	2
HMX-2B-3/8"	3/8"	3/8"	1"	2-1/2"	2
HMX-2B-25/64"	25/64"	7/16"	1"	2-3/4"	2
HMX-2B-13/32"	13/32"	7/16"	1"	2-3/4"	2
HMX-2B-27/64"	27/64"	7/16"	1"	2-3/4"	2
HMX-2B-7/16"	7/16"	7/16"	1"	2-3/4"	2
HMX-2B-29/64"	29/64"	1/2"	1"	3"	2
HMX-2B-15/32"	15/32"	1/2"	1"	3"	2
HMX-2B-31/64"	31/64"	1/2"	1"	3"	2
HMX-2B-1/2"	1/2"	1/2"	1"	3"	2
HMX-2B-9/16"	9/16"	9/16"	1-1/8"	3-1/2"	2
HMX-2B-5/8"	5/8"	5/8"	1-1/4"	3-1/2"	2
HMX-2B-11/16"	11/16"	3/4"	1-3/8"	4"	2
HMX-2B-3/4"	3/4"	3/4"	1-1/2"	4"	2
HMX-2B-7/8"	7/8"	7/8"	1-1/2"	4"	2
HMX-2B-1"	1"	1"	1-1/2"	4"	2

### 2-flute ball nose end mills with long straight shank

#### HMX-2BL

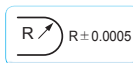
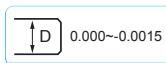
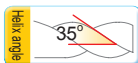
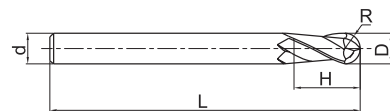
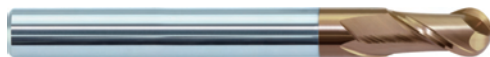

Art.No.	Specification				
	D	d	H	L	Z (Number of teeth)
HMX-2BL-1/8"	1/8"	1/8"	3/4"	2-1/4"	2
HMX-2BL-3/16"	3/16"	3/16"	3/4"	2-1/2"	2
HMX-2BL-1/4"	1/4"	1/4"	1-1/8"	3"	2
HMX-2BL-5/16"	5/16"	5/16"	1-1/8"	3"	2
HMX-2BL-3/8"	3/8"	3/8"	1-1/8"	3"	2

Art.No.	Specification				
	D	d	H	L	Z (Number of teeth)
HMX-2BL-7/16"	7/16"	7/16"	2"	4-1/2"	2
HMX-2BL-1/2"	1/2"	1/2"	2"	4-1/2"	2
HMX-2BL-5/8"	5/8"	5/8"	2-1/4"	5"	2
HMX-2BL-3/4"	3/4"	3/4"	2-1/4"	5"	2
HMX-2BL-1"	1"	1"	2-1/4"	5"	2

### 2-flute flattened end mills with straight shank

#### AL-2E

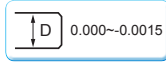
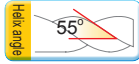
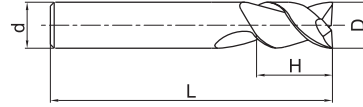

Art.No.	Specification				
	D	d	H	L	Z (Number of teeth)
AL-2E-1/16"	1/16"	1/8"	3/16"	1-1/2"	2
AL-2E-3/32"	3/32"	1/8"	3/8"	1-1/2"	2
AL-2E-1/8"	1/8"	1/8"	7/16"	1-1/2"	2
AL-2E-5/32"	5/32"	3/16"	9/16"	2"	2
AL-2E-3/16"	3/16"	3/16"	9/16"	2"	2
AL-2E-7/32"	7/32"	1/4"	5/8"	2-1/2"	2
AL-2E-1/4"	1/4"	1/4"	3/4"	2-1/2"	2
AL-2E-9/32"	9/32"	5/16"	3/4"	2-1/2"	2

Art.No.	Specification				
	D	d	H	L	Z (Number of teeth)
AL-2E-5/16"	5/16"	5/16"	13/16"	2-1/2"	2
AL-2E-3/8"	3/8"	3/8"	7/8"	2-1/2"	2
AL-2E-7/16"	7/16"	7/16"	1"	2-3/4"	2
AL-2E-1/2"	1/2"	1/2"	1"	3"	2
AL-2E-9/16"	9/16"	9/16"	1-1/8"	3-1/2"	2
AL-2E-5/8"	5/8"	5/8"	1-1/4"	3-1/2"	2
AL-2E-3/4"	3/4"	3/4"	1-1/2"	4"	2
AL-2E-1"	1"	1"	1-1/2"	4"	2

### 3-flute flattened end mills with straight shank

#### AL-3E

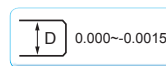
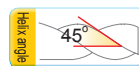
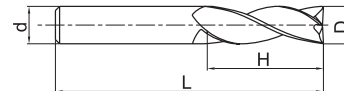

Art.No.	Specification				
	D	d	H	L	Z (Number of teeth)
AL-3E-1/16"	1/16"	1/8"	3/16"	1-1/2"	3
AL-3E-3/32"	3/32"	1/8"	3/8"	1-1/2"	3
AL-3E-1/8"	1/8"	1/8"	7/16"	1-1/2"	3
AL-3E-5/32"	5/32"	3/16"	9/16"	2"	3
AL-3E-3/16"	3/16"	3/16"	9/16"	2"	3
AL-3E-7/32"	7/32"	1/4"	5/8"	2-1/2"	3
AL-3E-1/4"	1/4"	1/4"	3/4"	2-1/2"	3
AL-3E-9/32"	9/32"	5/16"	3/4"	2-1/2"	3

Art.No.	Specification				
	D	d	H	L	Z (Number of teeth)
AL-3E-5/16"	5/16"	5/16"	13/16"	2-1/2"	3
AL-3E-3/8"	3/8"	3/8"	7/8"	2-1/2"	3
AL-3E-7/16"	7/16"	7/16"	1"	2-3/4"	3
AL-3E-1/2"	1/2"	1/2"	1"	3"	3
AL-3E-9/16"	9/16"	9/16"	1-1/8"	3-1/2"	3
AL-3E-5/8"	5/8"	5/8"	1-1/4"	3-1/2"	3
AL-3E-3/4"	3/4"	3/4"	1-1/2"	4"	3
AL-3E-1"	1"	1"	1-1/2"	4"	3

### 2-flute ball nose end mills with straight shank

#### AL-2B

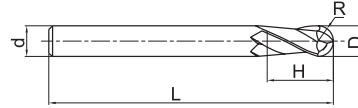

Art.No.	Specification				
	D	d	H	L	Z (Number of teeth)
AL-2B-1/8"	1/8"	1/4"	3/8"	2-1/2"	2
AL-2B-3/16"	3/16"	1/4"	9/16"	3"	2
AL-2B-1/4"	1/4"	1/4"	5/8"	3-1/2"	2
AL-2B-5/16"	5/16"	5/16"	11/16"	4"	2

Art.No.	Specification				
	D	d	H	L	Z (Number of teeth)
AL-2B-3/8"	3/8"	3/8"	7/8"	4"	2
AL-2B-1/2"	1/2"	1/2"	1"	4-1/2"	2
AL-2B-5/8"	5/8"	5/8"	1-1/8"	5"	2
AL-2B-3/4"	3/4"	3/4"	1-3/8"	5-1/4"	2

### 2-flute R end mills with straight shank

#### AL-2R-AIR for high-speed milling

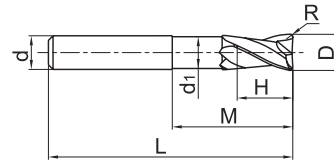

Art.No.	Specification							
	D	R	d	d <sub>1</sub>	H	M	L	Z (Number of teeth)
AL-2R-1/2"- AIR	1/2"	0.0547"	1/2"	0.4803"	3/8"	1-3/8"	3-1/4"	2
AL-2R-5/8"- AIR	5/8"	0.0625"	5/8"	0.6053"	1/2"	1-1/2"	3-1/2"	2

Art.No.	Specification							
	D	R	d	d <sub>1</sub>	H	M	L	Z (Number of teeth)
AL-2R-3/4"- AIR	3/4"	0.0781"	3/4"	0.7303"	9/16"	1-7/8"	4"	2

# High performance universal machining end mills

## UM series

- Variable pitch flutes with a variable helix reduce vibrations and allow for smoother cutting performance.
- The variable helix in the flutes and the variation in the flute gullets afford greater stability with improved chip evacuation and higher feed rates.

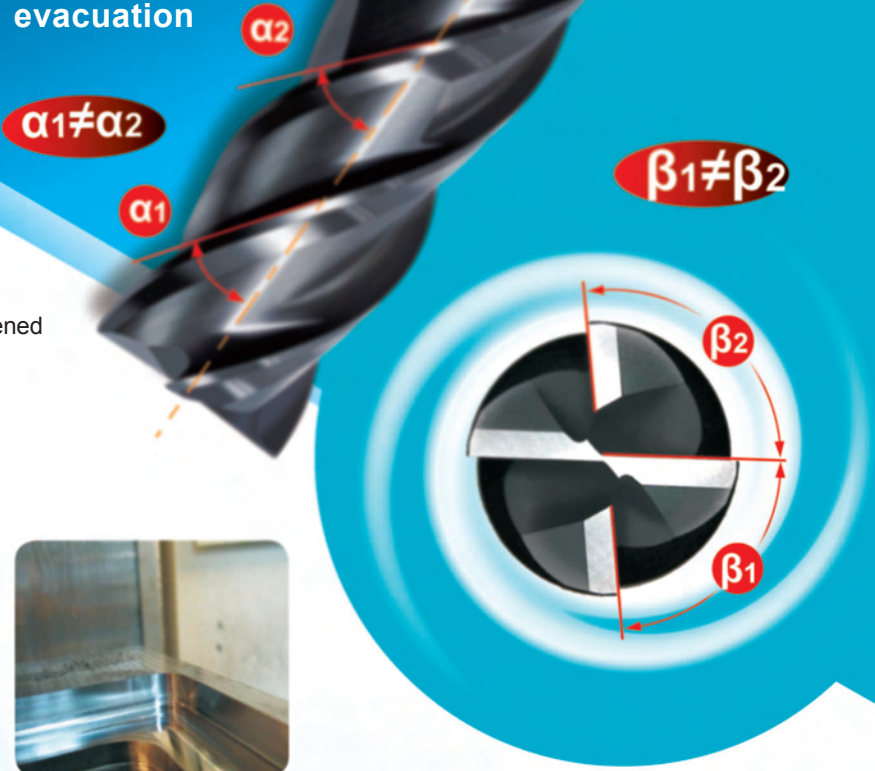

### Case study

Workpiece material: Precipitation Hardened Mold Steel  
 Milling style: cavity machining  
 Tool type: UM-4E-25/64"  
 Cutting parameter:  $n=5000\sim 6000\text{r/min}$ ,  
 $f_z=0.002\sim 0.006\text{IPT}$   
 $a_p=0.4\text{in}$   
 $a_e=0.04\text{in}$

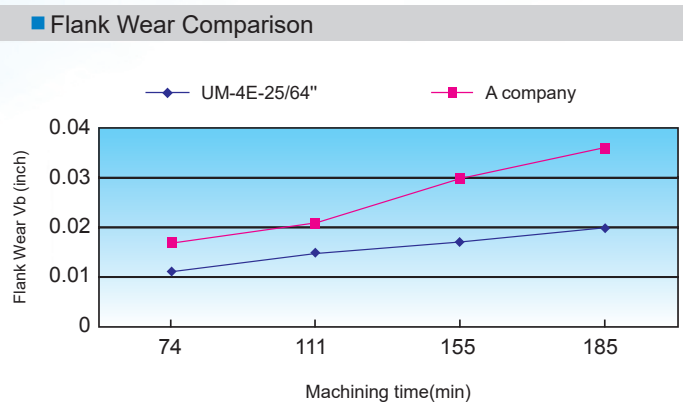
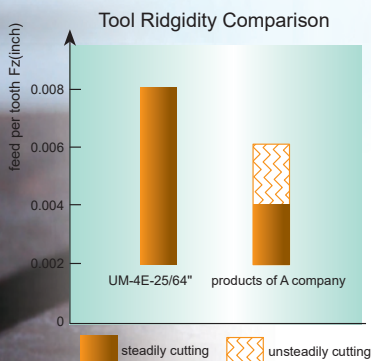

### 4-flute unequal pitch flattened end mills with straight shank

#### UM-4E

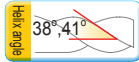
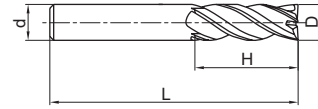

Art.No.	Specification				
	D	d	H	L	Z (Number of teeth)
UM-4E-3/64"	3/64"	1/8"	7/64"	1-1/2"	4
UM-4E-1/16"	1/16"	1/8"	3/16"	1-1/2"	4
UM-4E-5/64"	5/64"	1/8"	3/16"	1-1/2"	4
UM-4E-3/32"	3/32"	1/8"	9/32"	1-1/2"	4
UM-4E-7/64"	7/64"	1/8"	3/8"	1-1/2"	4
UM-4E-1/8"	1/8"	1/8"	1/2"	1-1/2"	4
UM-4E-9/64"	9/64"	3/16"	1/2"	2"	4
UM-4E-5/32"	5/32"	3/16"	1/2"	2"	4
UM-4E-11/64"	11/64"	3/16"	5/8"	2"	4
UM-4E-3/16"	3/16"	3/16"	5/8"	2"	4
UM-4E-13/64"	13/64"	1/4"	5/8"	2-1/2"	4
UM-4E-7/32"	7/32"	1/4"	5/8"	2-1/2"	4
UM-4E-15/64"	15/64"	1/4"	3/4"	2-1/2"	4
UM-4E-1/4"	1/4"	1/4"	3/4"	2-1/2"	4
UM-4E-17/64"	17/64"	5/16"	3/4"	2-1/2"	4
UM-4E-9/32"	9/32"	5/16"	3/4"	2-1/2"	4
UM-4E-19/64"	19/64"	5/16"	13/16"	2-1/2"	4
UM-4E-5/16"	5/16"	5/16"	13/16"	2-1/2"	4

Art.No.	Specification				
	D	d	H	L	Z (Number of teeth)
UM-4E-21/64"	21/64"	3/8"	1"	2-1/2"	4
UM-4E-11/32"	11/32"	3/8"	1"	2-1/2"	4
UM-4E-23/64"	23/64"	3/8"	1"	2-1/2"	4
UM-4E-3/8"	3/8"	3/8"	1"	2-1/2"	4
UM-4E-25/64"	25/64"	7/16"	1"	2-3/4"	4
UM-4E-13/32"	13/32"	7/16"	1"	2-3/4"	4
UM-4E-27/64"	27/64"	7/16"	1"	2-3/4"	4
UM-4E-7/16"	7/16"	7/16"	1"	2-3/4"	4
UM-4E-29/64"	29/64"	1/2"	1"	3"	4
UM-4E-15/32"	15/32"	1/2"	1"	3"	4
UM-4E-31/64"	31/64"	1/2"	1"	3"	4
UM-4E-1/2"	1/2"	1/2"	1-1/8"	3"	4
UM-4E-9/16"	9/16"	9/16"	1-1/8"	3-1/2"	4
UM-4E-5/8"	5/8"	5/8"	1-1/4"	3-1/2"	4
UM-4E-11/16"	11/16"	3/4"	1-3/8"	4"	4
UM-4E-3/4"	3/4"	3/4"	1-5/8"	4"	4
UM-4E-7/8"	7/8"	7/8"	1-5/8"	4"	4
UM-4E-1"	1"	1"	1-5/8"	4"	4

### 4-flute long cutting edge and unequal pitch flattened end mill with straight shank

#### UM-4EL

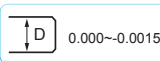
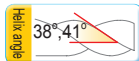
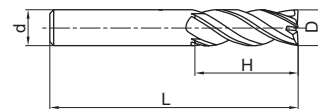

Art.No.	Specification				
	D	d	H	L	Z (Number of teeth)
UM-4EL-1/8"	1/8"	1/8"	3/4"	2-1/4"	4
UM-4EL-3/16"	3/16"	3/16"	3/4"	2-1/2"	4
UM-4EL-1/4"	1/4"	1/4"	1-1/8"	3"	4
UM-4EL-5/16"	5/16"	5/16"	1-1/8"	3"	4
UM-4EL-3/8"	3/8"	3/8"	1-1/8"	3"	4

Art.No.	Specification				
	D	d	H	L	Z (Number of teeth)
UM-4EL-7/16"	7/16"	7/16"	2"	4-1/2"	4
UM-4EL-1/2"	1/2"	1/2"	2-1/8"	4-1/2"	4
UM-4EL-5/8"	5/8"	5/8"	2-1/2"	5"	4
UM-4EL-3/4"	3/4"	3/4"	2-1/2"	5"	4
UM-4EL-1"	1"	1"	2-1/2"	5"	4



### 4-flute unequal pitch R end mill with straight shank

#### UM-4R

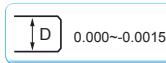
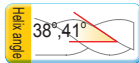
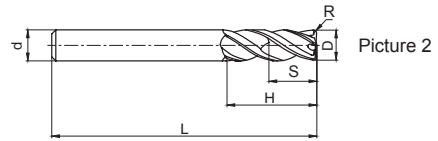
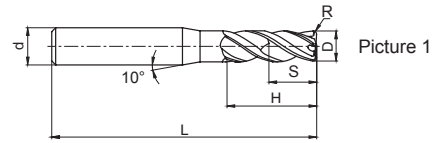

Art.No.	Specification						
	D	R	d	S	H	L	Z (Number of teeth)
UM-4R-1/8"-R010"	1/8"	0.010"	1/8"	3/16"	3/8"	1-1/2"	4
UM-4R-1/4"-R020"	1/4"	0.020"	1/4"	3/8"	3/4"	2-1/2"	4
UM-4R-1/4"-R030"	1/4"	0.030"	1/4"	3/8"	3/4"	2-1/2"	4
UM-4R-5/16"-R020"	5/16"	0.020"	5/16"	15/32"	13/16"	2-1/2"	4
UM-4R-3/8"-R020"	3/8"	0.020"	3/8"	9/16"	1"	2-1/2"	4

Art.No.	Specification						
	D	R	d	S	H	L	Z (Number of teeth)
UM-4R-1/2"-R020"	1/2"	0.020"	1/2"	3/4"	1"	3"	4
UM-4R-1/2"-R030"	1/2"	0.030"	1/2"	3/4"	1"	3"	4
UM-4R-5/8"-R030"	5/8"	0.030"	5/8"	15/16"	1-1/2"	3-1/2"	4
UM-4R-3/4"-R030"	3/4"	0.030"	3/4"	1-1/8"	1-1/2"	4"	4

# VSM series

VSM series end mills

Unequal pitch and variable inclined angle design

Very suitable for machining of hard-to-cut materials

such as stainless steel,

Ni substrate high temperature alloy, etc.

**VSM-4E**

**VSM-4EL**

**VSM-4RFP**

**VSM-4R**

**VSM-4EFP**

**VSM-4RL**

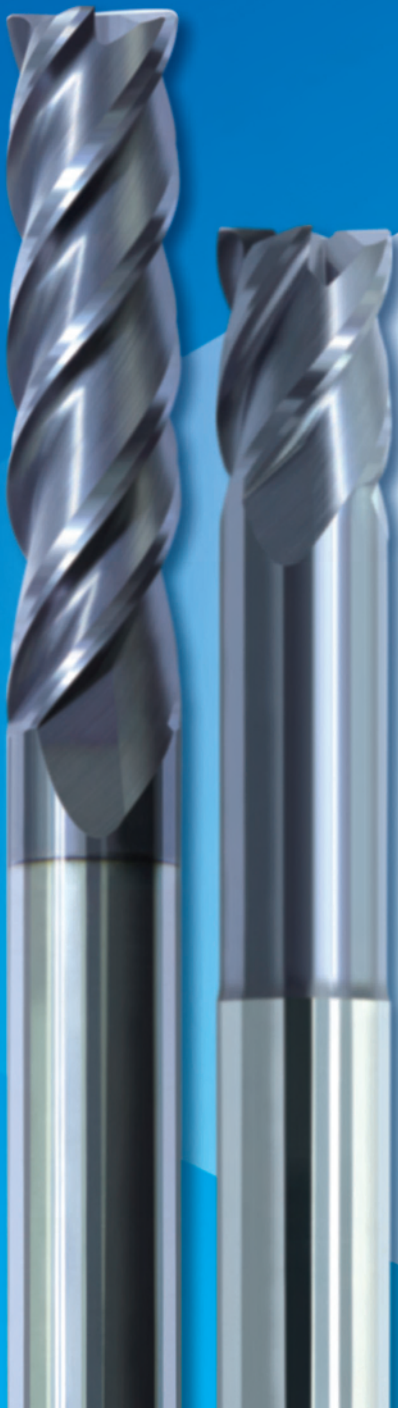

## 🔧 VSM-4E-1/2" Slot Milling of Stainless Steel

Machine Tool : MIKRON UCP1000

Tool Holder : HSK63-A

Workpiece Material : 1Cr18Ni9Ti

Cutting Speed : 3150 RPM

Feed Rate/ Tooth : 0.002/ tooth

Axial Cutting Depth : 1/4"

Radial Cutting Depth : 1/2"

Cooling Method : Water Cooling

Milling Style : Slot Milling

Overhang : 1-3/8"

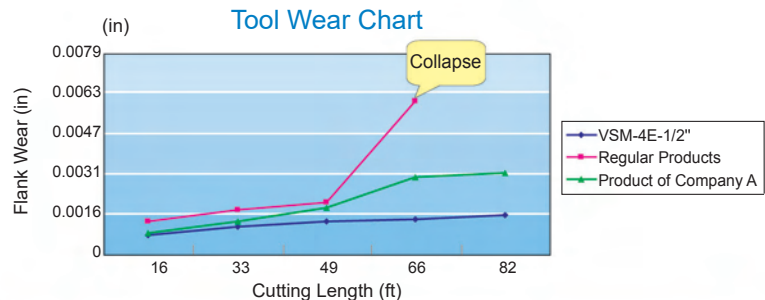
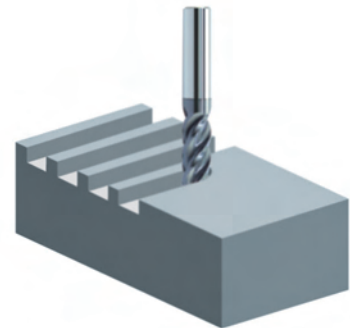

Note: • Compare with similar products, VSM Endmills have better wear resistance and longer tool life.  
• Compare with ordinary endmills, VSM series have a much better chipping resistance.

### 4-flute unequal pitch flattened end mill with straight shank

#### VSM-4E

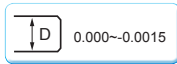
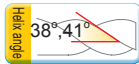
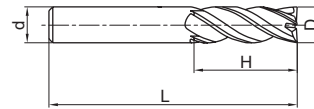

Art.No.	Specification				
	D	d	H	L	Z (Number of teeth)
VSM-4E-1/8"	1/8"	1/8"	1/2"	2"	4
VSM-4E-3/16"	3/16"	3/16"	5/8"	2-1/2"	4
VSM-4E-1/4"	1/4"	1/4"	3/4"	2-1/2"	4
VSM-4E-5/16"	5/16"	5/16"	13/16"	2-1/2"	4
VSM-4E-3/8"	3/8"	3/8"	1"	2-1/2"	4

Art.No.	Specification				
	D	d	H	L	Z (Number of teeth)
VSM-4E-1/2"	1/2"	1/2"	1-1/4"	3"	4
VSM-4E-5/8"	5/8"	5/8"	1-1/2"	3-1/2"	4
VSM-4E-3/4"	3/4"	3/4"	1-3/4"	4"	4
VSM-4E-1"	1"	1"	1-3/4"	4"	4

### 4-flute flattened endmills with straight shank and long cutting edge

#### VSM-4EL

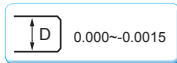
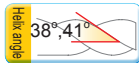
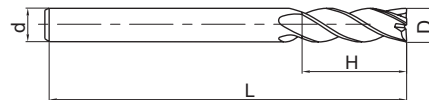

Art.No.	Specification				
	D	d	H	L	Z (Number of teeth)
VSM-4EL-3/16"	3/16"	3/16"	3/4"	2-1/2"	4
VSM-4EL-1/4"	1/4"	1/4"	1-1/8"	3"	4
VSM-4EL-5/16"	5/16"	5/16"	1-1/4"	3"	4

Art.No.	Specification				
	D	d	H	L	Z (Number of teeth)
VSM-4EL-3/8"	3/8"	3/8"	1-1/4"	3"	4
VSM-4EL-1/2"	1/2"	1/2"	1-3/4"	4"	4
VSM-4EL-5/8"	5/8"	5/8"	2-1/8"	4"	4

### 4-flute unequal pitch flattened end mill with long neck, short cutting edge and straight shank

#### VSM-4EFP

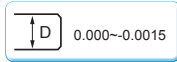
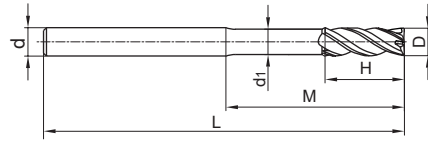

Art.No.	Specification						
	D	d	H	M	d <sub>1</sub>	L	Z (Number of teeth)
VSM-4EFP-1/4"	1/4"	1/4"	3/8"	1-1/16"	15/64"	3"	4
VSM-4EFP-3/8"	3/8"	3/8"	1/2"	1-1/2"	23/64"	4"	4

Art.No.	Specification						
	D	d	H	M	d <sub>1</sub>	L	Z (Number of teeth)
VSM-4EFP-1/2"	1/2"	1/2"	5/8"	2"	31/64"	4"	4
VSM-4EFP-5/8"	5/8"	5/8"	3/4"	2-3/8"	39/64"	6"	4

### 4-flute radius endmills

#### VSM-4R

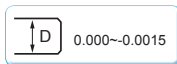
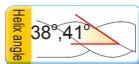
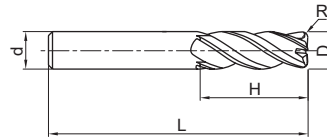

Art.No.	Specification					
	D	R	d	H	L	Z (Number of teeth)
VSM-4R-1/8"R010	1/8"	0.010"	1/8"	1/2"	2"	4
VSM-4R-1/4"R020	1/4"	0.020"	1/4"	3/4"	2-1/2"	4
VSM-4R-1/4"R030	1/4"	0.030"	1/4"	3/4"	2-1/2"	4
VSM-4R-5/16"R020	5/16"	0.020"	5/16"	13/16"	2-1/2"	4
VSM-4R-3/8"R020	3/8"	0.020"	3/8"	1"	2-1/2"	4

Art.No.	Specification					
	D	R	d	H	L	Z (Number of teeth)
VSM-4R-1/2"R020	1/2"	0.020"	1/2"	1-1/4"	3"	4
VSM-4R-1/2"R030	1/2"	0.030"	1/2"	1-1/4"	3"	4
VSM-4R-5/8"R030	5/8"	0.030"	5/8"	1-1/2"	3-1/2"	4
VSM-4R-3/4"R030	3/4"	0.030"	3/4"	1-1/2"	4"	4
VSM-4R-1"R030	1"	0.030"	1"	1-1/2"	4"	4



### 4-flute radius endmills with straight shank and long cutting edge

#### VSM-4RL

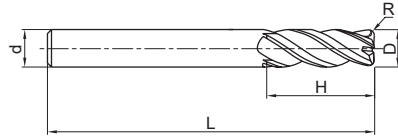

Art.No.	Specification					
	D	R	d	H	L	Z (Number of teeth)
VSM-4RL-3/16"-R010"	3/16"	0.010"	3/16"	3/4"	2-1/2"	4
VSM-4RL-3/16"-R020"	3/16"	0.020"	3/16"	3/4"	2-1/2"	4
VSM-4RL-1/4"-R020"	1/4"	0.020"	1/4"	1-1/8"	3"	4
VSM-4RL-5/16"-R020"	5/16"	0.020"	5/16"	1-1/4"	3"	4
VSM-4RL-3/8"-R020"	3/8"	0.020"	3/8"	2"	3-1/2"	4
VSM-4RL-1/2"-R020"	1/2"	0.020"	1/2"	2-1/2"	4-1/2"	4

Art.No.	Specification					
	D	R	d	H	L	Z (Number of teeth)
VSM-4RL-1/2"-R030"	1/2"	0.030"	1/2"	2-1/2"	4-1/2"	4
VSM-4RL-5/8"-R030"	5/8"	0.030"	5/8"	3"	5"	4
VSM-4RL-5/8"-R060"	5/8"	0.060"	5/8"	2-1/8"	4"	4
VSM-4RL-3/4"-R030"	3/4"	0.030"	3/4"	3"	5"	4
VSM-4RL-3/4"-R060"	3/4"	0.060"	3/4"	3"	5"	4
VSM-4RL-1"-R060"	1"	0.060"	1"	3"	5"	4

### 4-flute long neck and short cutting edge unequal pitch R end mill with straight shank

#### VSM-4RFP

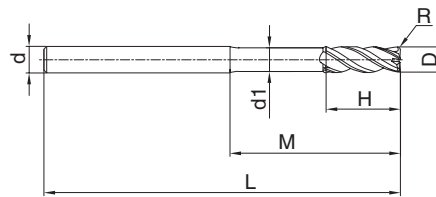

Art.No.	Specification							
	D	R	d	d <sub>1</sub>	H	M	L	Z (Number of teeth)
VSM-4RFP-1/4" R020	1/4"	0.020"	1/4"	15/64"	3/8"	1-1/16"	3"	4
VSM-4RFP-1/4" R040	1/4"	0.040"	1/4"	15/64"	3/8"	1-1/16"	3"	4
VSM-4RFP-3/8" R020	3/8"	0.020"	3/8"	23/64"	1/2"	1-1/2"	4"	4
VSM-4RFP-3/8" R040	3/8"	0.040"	3/8"	23/64"	1/2"	1-1/2"	4"	4

Art.No.	Specification							
	D	R	d	d <sub>1</sub>	H	M	L	Z (Number of teeth)
VSM-4RFP-1/2" R020	1/2"	0.020"	1/2"	31/64"	1/2"	1-1/2"	4"	4
VSM-4RFP-1/2" R040	1/2"	0.040"	1/2"	31/64"	1/2"	1-1/2"	4"	4
VSM-4RFP-5/8" R030	5/8"	0.030"	5/8"	39/64"	3/4"	2-3/8"	6"	4
VSM-4RFP-5/8" R060	5/8"	0.060"	5/8"	39/64"	3/4"	2-3/8"	6"	4

### Cutting data of GM series flattened end mills

Workpiece materials	Carbon steel, alloy steel, tool steel, die steel		Alloy steel, tool steel, die steel, hardened steel		Alloy steel, tool steel, Stainless steel, die steel, hardened steel		Hardened steel, Ti alloy		Hardened steel, heat-resistant steel, Ni-based alloy	
	HRC<30		HRC(30-35)		HRC(35-40)		HRC(40-45)		HRC(45-50)	
Hardness of workpiece materials										
Cutting edge diameter of end mills (inch)	Rotation speed (r/min)	Feed (IPT)	Rotation speed (r/min)	Feed (IPT)	Rotation speed (r/min)	Feed (IPT)	Rotation speed (r/min)	Feed (IPT)	Rotation speed (r/min)	Feed (IPT)
1/32"	25000	0.00008	21000	0.00008	16800	0.00008	14500	0.00008	5200	0.00008
3/64"	20000	0.00010	16700	0.00010	13400	0.00010	11700	0.00010	4200	0.00010
1/16"	14000	0.00016	12000	0.00016	9600	0.00016	8400	0.00016	3000	0.00016
5/64"	13000	0.00020	11000	0.00020	8800	0.00020	7700	0.00020	2800	0.00020
3/32"	12000	0.00024	9200	0.00024	7400	0.00024	6400	0.00024	2300	0.00024
7/64"	12000	0.00028	9200	0.00028	7400	0.00028	6400	0.00028	2300	0.00028
1/8"	12000	0.00032	9200	0.00032	7400	0.00032	6400	0.00032	2300	0.00032
9/64"	10600	0.00040	8800	0.00040	7000	0.00040	6100	0.00040	2200	0.00040
5/32"	9600	0.00052	8000	0.00052	6400	0.00052	5600	0.00052	2000	0.00052
11/64"	8600	0.00060	7200	0.00060	5700	0.00060	5000	0.00060	1800	0.00060
3/16"	8000	0.00064	6700	0.00064	5400	0.00064	4700	0.00064	1700	0.00064
13/64"	7400	0.00072	6200	0.00072	5000	0.00072	4300	0.00072	1600	0.00072
7/32"	6800	0.00080	5700	0.00080	4600	0.00080	4000	0.00080	1400	0.00080
15/64"	6400	0.00096	5300	0.00096	4200	0.00096	3700	0.00096	1300	0.00096
1/4"	6000	0.0010	5000	0.0010	4000	0.0010	3500	0.0010	1300	0.0010
17/64"	5600	0.0010	4600	0.0010	3700	0.0010	3200	0.0010	1200	0.0010
9/32"	5300	0.00112	4400	0.00112	3500	0.00112	3000	0.00112	1100	0.00112
19/64"	5000	0.00120	4200	0.00120	3300	0.00120	2900	0.00120	1100	0.00120
5/16"	4800	0.00128	4000	0.00128	3200	0.00128	2800	0.00128	1000	0.00128
21/64"	4500	0.00128	3700	0.00128	3000	0.00128	2600	0.00128	950	0.00128
11/32"	4300	0.00136	3600	0.00136	2900	0.00136	2500	0.00136	900	0.00136
23/64"	4100	0.00144	3400	0.00144	2700	0.00144	2400	0.00144	850	0.00144
3/8"	4000	0.00152	3300	0.00152	2600	0.00152	2300	0.00152	850	0.00152
25/64"	3800	0.00160	3200	0.00160	2500	0.00160	2200	0.00160	800	0.00160
13/32"	3600	0.00168	3000	0.00168	2400	0.00168	2100	0.00168	750	0.00168
27/64"	3500	0.00176	2900	0.00176	2300	0.00176	2000	0.00176	750	0.00176
7/16"	3400	0.00184	2800	0.00184	2200	0.00184	1900	0.00184	700	0.00184
29/64"	3300	0.00192	2700	0.00192	2100	0.00192	1800	0.00192	700	0.00192
15/32"	3100	0.00200	2600	0.00200	2000	0.00200	1700	0.00200	650	0.00200
31/64"	3000	0.00200	2500	0.00200	2000	0.00200	1600	0.00200	600	0.00200
1/2"	3000	0.00200	2500	0.00200	2000	0.00200	1600	0.00200	600	0.00200
9/16"	2600	0.00200	2200	0.00200	1800	0.00200	1600	0.00200	550	0.00200
5/8"	2400	0.00200	2000	0.00200	1600	0.00200	1400	0.00200	500	0.00200
11/16"	2200	0.00200	1800	0.00200	1400	0.00200	1300	0.00200	450	0.00200
3/4"	2000	0.00200	1600	0.00200	1300	0.00200	1100	0.00200	400	0.00200
7/8"	1700	0.00240	1400	0.00240	1100	0.00240	1000	0.00240	350	0.00240
1"	1500	0.00320	1250	0.00320	1000	0.00320	700	0.00320	300	0.00320



### Cutting data of GM series flattened end mills

Workpiece materials	Carbon steel, alloy steel, tool steel, die steel	Alloy steel, tool steel, die steel, hardened steel	Alloy steel, tool steel, Stainless steel, die steel, hardened steel	Hardened steel, Ti alloy	Hardened steel, heat-resistant steel, Ni-based alloy
Hardness of workpiece materials	HRC<30	HRC(30-35)	HRC(35-40)	HRC(40-45)	HRC(45-50)
Max cutting data (Feed speed 100%)	<p><math>a_e &lt; 1/8 \text{ inch}</math>, <math>a_p &lt; 0.15D</math>  <math>a_e &gt; 1/8 \text{ inch}</math>, <math>a_p &lt; 0.25D</math></p>			<p><math>a_e &lt; 1/8 \text{ inch}</math>, <math>a_p &lt; 0.05D</math>  <math>a_e &gt; 1/8 \text{ inch}</math>, <math>a_p &lt; 0.10D</math></p>	
Max cutting data (Feed speed 120%)	<p><math>a_p &lt; 1.5D</math>, <math>a_e &lt; 0.05D</math></p>			<p><math>a_p &lt; 1.5D</math>, <math>a_e &lt; 0.025D</math></p>	

- We suggest a feed and speed 50% of that stated as a starting point and gradually increase as machining stability is determined.
- A high quality and precision end mill toolholding system is highly recommended. Runout of alignment should not exceed .0004". Reduce tool overhang, as much as possible.

### Cutting parameters of GM series ball nose end mills

Workpiece materials	Carbon steel, alloy steel, tool steel				Alloy steel, tool steel, Stainless steel, treatment steel				Hardened steel			
Hardness of workpiece materials	HRC<30				HRC(30-45)				HRC(40-50)			
Cutting edge diameter of end mills (inch)	Contour milling		Profile milling		Contour milling		Profile milling		Contour milling		Profile milling	
	Rotation speed (r/min)	Feed (IPT)	Rotation speed (r/min)	Feed (IPT)	Rotation speed (r/min)	Feed (IPT)	Rotation speed (r/min)	Feed (IPT)	Rotation speed (r/min)	Feed (IPT)	Rotation speed (r/min)	Feed (IPT)
1/32"	40000	0.0002	32000	0.0002	34000	0.00016	28000	0.00016	20000	0.00012	12000	0.00012
3/64"	37000	0.0004	26500	0.0004	32000	0.00032	21000	0.00032	16000	0.00024	11000	0.00024
1/16"	28000	0.0006	20000	0.0006	24000	0.00048	16000	0.00048	12000	0.00032	8000	0.00032
5/64"	22300	0.0008	16000	0.0008	19000	0.00064	13000	0.00064	9500	0.00044	7000	0.00044
3/32"	18600	0.00092	13000	0.00092	16000	0.00072	10600	0.00072	8000	0.00052	5300	0.00052
7/64"	16000	0.00104	11400	0.00104	14000	0.0008	9000	0.0008	7000	0.0006	4500	0.0006
1/8"	14000	0.0012	10000	0.0012	12000	0.00096	8000	0.00096	6000	0.00068	4000	0.00068
9/64"	12400	0.0014	8800	0.0014	11000	0.0012	7100	0.0012	5500	0.00088	3600	0.00088
5/32"	11100	0.0016	8000	0.0016	10000	0.0014	6400	0.0014	5000	0.00112	3200	0.00112
11/64"	10100	0.00172	7200	0.00172	8700	0.0016	5800	0.0016	4400	0.00132	2900	0.00132
3/16"	9300	0.00184	6600	0.00184	8000	0.00168	5300	0.00168	4000	0.0014	2700	0.0014
13/64"	8600	0.002	6100	0.002	7400	0.0018	4900	0.0018	3700	0.00152	2500	0.00152
7/32"	8000	0.0022	5700	0.0022	6800	0.0020	4500	0.0020	3400	0.00168	2300	0.00168
15/64"	7400	0.0024	5300	0.0024	6400	0.00224	4200	0.00224	3200	0.00188	2100	0.00188
1/4"	7000	0.0026	5000	0.0026	6000	0.0024	4000	0.0024	3000	0.002	2000	0.002
17/64"	6500	0.0028	4700	0.0028	5600	0.0026	3700	0.0026	2800	0.0022	1900	0.0022
9/32"	6200	0.0032	4400	0.0032	5300	0.003	3500	0.003	2700	0.0024	1800	0.0024
19/64"	5900	0.0036	4200	0.0036	5000	0.0032	3400	0.0032	2500	0.0026	1700	0.0026
5/16"	5600	0.0040	4000	0.0040	4800	0.00344	3200	0.00344	2400	0.0028	1600	0.0028
21/64"	5300	0.0040	3800	0.0040	4500	0.00344	3000	0.00344	2300	0.00296	1500	0.00296
11/32"	5000	0.0042	3600	0.0042	4300	0.0036	2900	0.0036	2200	0.00316	1400	0.00316
23/64"	4800	0.0044	3500	0.0044	4200	0.0038	2800	0.0038	2100	0.00328	1400	0.00328
3/8"	4600	0.0046	3400	0.0046	4000	0.0038	2700	0.0038	2000	0.00328	1300	0.00328
25/64"	4500	0.0048	3300	0.0048	3800	0.0040	2600	0.0040	1900	0.00348	1300	0.00348
13/32"	4300	0.0048	3200	0.0048	3700	0.0040	2500	0.0040	1800	0.00348	1200	0.00348
27/64"	4100	0.0050	3100	0.0050	3500	0.0044	2400	0.0044	1600	0.00368	1200	0.00368
7/16"	4000	0.0050	3000	0.0050	3400	0.0044	2300	0.0044	1700	0.00368	1200	0.00368
29/64"	3800	0.0052	2800	0.0052	3300	0.0048	2200	0.0048	1400	0.00388	1100	0.00388
15/32"	3700	0.0052	2700	0.0052	3200	0.0048	2100	0.0048	1600	0.00388	1100	0.00388
31/64"	3600	0.0054	2600	0.0054	3100	0.0050	2000	0.0050	1500	0.0042	1000	0.0042
1/2"	3500	0.0056	2500	0.0056	3000	0.0052	1900	0.0052	1500	0.0044	1000	0.0044
9/16"	3100	0.0060	2200	0.0060	2700	0.0056	1800	0.0056	1400	0.0046	900	0.0046
5/8"	2800	0.0064	2000	0.0064	2400	0.00584	1600	0.00584	1200	0.0048	800	0.0048
11/16"	2600	0.0066	1800	0.0066	2200	0.006	1500	0.006	1100	0.00496	800	0.00496
3/4"	2400	0.0068	1700	0.0068	2000	0.0064	1300	0.0064	1000	0.00508	700	0.00508
7/8"	2000	0.0072	1500	0.0072	1700	0.0068	1100	0.0068	900	0.0052	600	0.0052
1"	1800	0.0088	1300	0.0088	1500	0.008	1000	0.008	800	0.0072	400	0.0072





### Cutting parameters of GM series ball nose end mills

Workpiece materials	Carbon steel, alloy steel, tool steel, die steel	Alloy steel, tool steel, die steel, hardened steel	Hardened steel, Ti alloy
Hardness of workpiece materials	HRC<30	HRC(30-35)	HRC(40-45)
Max cutting date	<p><math>a_p &lt; 0.06R</math>, <math>a_e &lt; 0.10R</math></p>		<p><math>a_p &lt; 0.03R</math>, <math>a_e &lt; 0.05R</math></p>

- We suggest a feed and speed 50% of that stated as a starting point gradually increase as machining stability is determined.
- A high quality and precision end mill toolholding system is highly recommended. Runout of alignment should not exceed .0004".

### Cutting data of GM series R end mills

Workpiece materials	Carbon steel, alloy steel, tool steel, die steel		Alloy steel, tool steel, die steel, hardened steel		Alloy steel, tool steel, Stainless steel, die steel, hardened steel		Hardened steel, Ti alloy		Hardened steel, heat-resistant steel, Ni-based alloy	
Hardness of workpiece materials	HRC<30		HRC(30-35)		HRC(35-40)		HRC(40-45)		HRC(45-50)	
Cutting edge diameter of end mills (inch)	Rotation speed (r/min)	Feed (IPT)	Rotation speed (r/min)	Feed (IPT)	Rotation speed (r/min)	Feed (IPT)	Rotation speed (r/min)	Feed (IPT)	Rotation speed (r/min)	Feed (IPT)
1/8"	12000	0.00032	9200	0.00032	7400	0.00032	6400	0.00032	2300	0.00032
3/16"	8000	0.00064	6700	0.00064	5400	0.00064	4700	0.00064	1700	0.00064
1/4"	6000	0.0010	5000	0.0010	4000	0.0010	3500	0.0010	1300	0.0010
5/16"	4800	0.00128	4000	0.00128	3200	0.00128	2800	0.00128	1000	0.00128
3/8"	4000	0.00152	3300	0.00152	2600	0.00152	2300	0.00152	850	0.00152
1/2"	3000	0.00200	2500	0.00200	2000	0.00200	1600	0.00200	600	0.00200
Max cutting date	Maximum stock removal in milling grooves (Feed speed 100%) <p><math>a_p &lt; 0.25D</math></p>					Maximum stock removal in side milling (Feed speed 120%) <p><math>a_p &lt; 1.5D</math>, <math>a_e &lt; 0.05D</math></p>				

- We suggest a feed and speed 50% of that stated as a starting point and gradually increase as machining stability is determined.
- A high quality and precision end mill toolholding system is highly recommended. Runout of alignment should not exceed .0004".

### Cutting parameters of GM series of tiny diameter flattened end mills

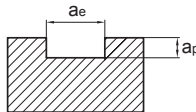
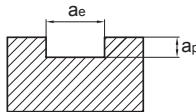
Workpiece materials	Carbon steel, alloy steel, tool steel, die steel		Alloy steel, tool steel, die steel, hardened steel		Alloy steel, tool steel, Stainless steel, die steel, hardened steel		Hardened steel, Ti alloy		Hardened steel, heat-resistant steel, Ni-based alloy	
Hardness of workpiece materials	HRC<30		HRC(30-35)		HRC(35-40)		HRC(40-45)		HRC(45-50)	
Cutting edge diameter of end mills (inch)	Rotation speed (r/min)	Feed (IPT)	Rotation speed (r/min)	Feed (IPT)	Rotation speed (r/min)	Feed (IPT)	Rotation speed (r/min)	Feed (IPT)	Rotation speed (r/min)	Feed (IPT)
0.012	32000	0.00004	32000	0.00004	29000	0.00004	24000	0.00004	18000	0.00004
0.013	32000	0.00004	32000	0.00004	29000	0.00004	24000	0.00004	18000	0.00004
0.014	32000	0.00004	32000	0.00004	29000	0.00004	24000	0.00004	18000	0.00004
0.015	32000	0.00004	32000	0.00004	29000	0.00004	24000	0.00004	18000	0.00004
0.016	32000	0.00004	32000	0.00004	29000	0.00004	24000	0.00004	18000	0.00004
0.017	32000	0.00004	32000	0.00004	29000	0.00004	24000	0.00004	18000	0.00004
0.018	32000	0.00004	32000	0.00004	29000	0.00004	24000	0.00004	18000	0.00004
0.019	32000	0.00004	32000	0.00004	29000	0.00004	24000	0.00004	18000	0.00004
0.020	32000	0.00006	32000	0.00006	29000	0.00006	24000	0.00006	18000	0.00006
0.021	32000	0.00006	32000	0.00006	29000	0.00006	24000	0.00006	18000	0.00006
0.022	32000	0.00006	32000	0.00006	29000	0.00006	24000	0.00006	18000	0.00006
0.023	32000	0.00006	32000	0.00006	29000	0.00006	24000	0.00006	18000	0.00006
0.024	32000	0.00006	32000	0.00006	29000	0.00006	24000	0.00006	18000	0.00006
0.025	32000	0.00006	32000	0.00006	29000	0.00006	24000	0.00006	18000	0.00006
0.026	32000	0.00006	32000	0.00006	29000	0.00006	24000	0.00006	18000	0.00006
0.027	32000	0.00006	32000	0.00006	29000	0.00006	24000	0.00006	18000	0.00006
0.028	32000	0.00006	32000	0.00006	29000	0.00006	24000	0.00006	18000	0.00006
0.029	32000	0.00006	32000	0.00006	29000	0.00006	24000	0.00006	18000	0.00006
0.030	32000	0.00006	32000	0.00006	29000	0.00006	24000	0.00006	18000	0.00006
0.031	25000	0.00008	21000	0.00008	16800	0.00008	14500	0.00008	5200	0.00008
0.035	25000	0.00008	21000	0.00008	16800	0.00008	14500	0.00008	5200	0.00008
0.040	25000	0.00008	21000	0.00008	16800	0.00008	14500	0.00008	5200	0.00008
0.047	20000	0.00010	16700	0.00010	13400	0.00010	11700	0.00010	4200	0.00010
0.050	20000	0.00012	16700	0.00012	13400	0.00012	11700	0.00012	4200	0.00012
0.055	14000	0.00014	12000	0.00014	9600	0.00014	8400	0.00014	3000	0.00014
0.060	14000	0.00016	12000	0.00016	9600	0.00016	8400	0.00016	3000	0.00016
Maximum stock removal in milling grooves (Feed speed 100%)	 <p><math>a_e &lt; 0.031 \text{ inch}</math>, <math>a_p &lt; 0.1D</math>  <math>a_e &gt; 0.031 \text{ inch}</math>, <math>a_p &lt; 0.15D</math></p>					 <p><math>a_e &lt; 0.031 \text{ inch}</math>, <math>a_p &lt; 0.05D</math>  <math>a_e &gt; 0.031 \text{ inch}</math>, <math>a_p &lt; 0.10D</math></p>				

- We suggest a feed and speed 50% of that stated as a starting point and gradually increase as machining stability is determined.
- A high quality and precision end mill toolholding system is highly recommended. Runout of alignment should not exceed .0004".

### GM-4W — side cutting

Workpiece material	Cast iron, Nodular cast iron		Carbon steel, Alloy steel ~750N/mm <sup>2</sup>		Carbon steel, Alloy steel ~30HRC		Pre-hardened steel, quenched and tempered steel ~40HRC		Stainless steel	
	Rotation speed (r/min)	Feed (in/min)	Rotation speed (r/min)	Feed (in/min)	Rotation speed (r/min)	Feed (in/min)	Rotation speed (r/min)	Feed (in/min)	Rotation speed (r/min)	Feed (in/min)
1/4"	6350	29.9	5300	25.2	4500	14.2	3450	11.0	2650	8.3
3/8"	3800	29.9	3200	25.2	2700	16.9	2050	13.0	1600	10.2
1/2"	3200	30.3	2250	25.6	1950	18.5	1500	14.2	1150	11.0
5/8"	2400	30.3	2000	25.2	1700	18.9	1300	14.2	1000	11.0
3/4"	1900	29.9	1600	24.0	1350	18.5	1050	13.8	800	10.2
Max cutting date										

- Please select high-precision machine and tool holder.
- Please use air blow or cutting liquid with high mist retardant property.
- Down milling is recommended in the case of side milling.
- When the machine rigidity and workpiece fixture stability is low, vibration and abnormal noise may be generated. Please reduce the rotating speed and feed speed stated above correspondingly.
- Make overhang of tool as short as possible in conditions of non-interference.

### GM-4W — slot cutting

Workpiece material	Cast iron, Nodular cast iron		Carbon steel, Alloy steel ~750N/mm <sup>2</sup>		Carbon steel, Alloy steel ~30HRC		Pre-hardened steel, quenched and tempered steel ~40HRC		Stainless steel	
Cutting speed	260-350SFPM		230-330SFPM		200-300SFPM		130-230SFPM		100-200SFPM	
Cutting edge diameter of end mills (inch)	Rotating speed (r/min)	Feed speed (in/min)	Rotating speed (r/min)	Feed speed (in/min)	Rotating speed (r/min)	Feed speed (in/min)	Rotating speed (r/min)	Feed speed (in/min)	Rotating speed (r/min)	Feed speed (in/min)
1/4"	5300	25.2	4500	21.3	3700	11.8	2900	9.1	2400	7.5
3/8"	3200	25.2	2200	21.3	2250	14.2	1750	11.0	1450	9.1
1/2"	2650	25.2	2250	21.3	1850	14.6	1450	11.4	1200	9.4
5/8"	2000	25.2	1700	21.3	1400	15.4	1100	12.2	900	9.8
3/4"	1600	25.2	1350	20.1	1100	15.4	900	11.8	700	9.1
Max cutting data	<p>Maximum <math>a_p = 0.472\text{in}</math></p>						<p><math>a_p = 0.5D</math></p>			

- Please select high-precision machine and tool holder.
- Please use air blow or cutting liquid with high mist retardant property.
- When the machine rigidity and workpiece fixture stability is low, vibration and abnormal noise may be generated. Please reduce the rotating speed and feed speed stated above correspondingly.
- Make overhang of tool as short as possible in conditions of non-interference.

### HMX-4E ★ HMX-4EL

Workpiece materials	Pre-hardened steel, Hardened steel 40~50HRC		Hardened steel 50~60HRC		Hardened steel 60~68HRC	
	Diameter (inch)	Rotating speed (r/min)	Feed speed (IPT)	Rotating speed (r/min)	Feed speed (IPT)	Rotating speed (r/min)
1/32"	40000	0.00009	40000	0.00008	40000	0.00063
3/64"	40000	0.00014	40000	0.00012	40000	0.00094
1/16"	40000	0.00019	40000	0.00016	30000	0.00125
5/64"	40000	0.00023	3200	0.00020	24000	0.00156
3/32"	40000	0.00028	26700	0.00023	20000	0.00188
7/64"	34000	0.00033	22900	0.00027	17000	0.00219
1/8"	30000	0.00038	20000	0.00031	15000	0.00250
9/64"	26700	0.00042	17800	0.00035	13000	0.00281
5/32"	24000	0.00047	16000	0.00039	12000	0.00313
11/64"	21800	0.00052	14500	0.00043	10900	0.00344
3/16"	20000	0.00056	13300	0.00047	10000	0.00375
13/64"	18500	0.00061	12300	0.00051	9200	0.00406
7/32"	17200	0.00066	11400	0.00055	8600	0.00438
15/64"	16000	0.00070	10700	0.00059	8000	0.00469
1/4"	15000	0.00075	10000	0.00063	7500	0.00500
17/64"	14000	0.00080	9400	0.00066	7000	0.00531
9/32"	13400	0.00084	8900	0.00070	6600	0.00563
19/64"	12700	0.00089	8400	0.00074	6300	0.00594
5/16"	12000	0.00094	8000	0.00078	6000	0.00625
21/64"	11500	0.00098	7600	0.00082	5700	0.00656
11/32"	11000	0.00103	7300	0.00086	5400	0.00688
23/64"	10500	0.00108	7000	0.00090	5200	0.00719
3/8 "	10000	0.00113	6600	0.00094	5000	0.00750
25/64"	9600	0.00117	6400	0.00098	4800	0.00781
13/32"	9200	0.00122	6100	0.00102	4600	0.00813
27/64"	8900	0.00127	5900	0.00105	4400	0.00844
7/16"	8600	0.00131	5700	0.00109	4300	0.00875
29/64"	8300	0.00136	5500	0.00113	4100	0.00906
15/32"	8000	0.00141	5300	0.00117	4000	0.00938
31/64"	7800	0.00145	5100	0.00121	3800	0.00969
1/2 "	7500	0.00150	5000	0.00125	3700	0.01000
9/16"	6700	0.00169	4400	0.00141	3300	0.01125
5/8 "	6000	0.00188	4000	0.00156	3000	0.01250
11/16"	5500	0.00206	3600	0.00172	2700	0.01375
3/4 "	5000	0.00225	3300	0.00188	2500	0.01500
7/8 "	4300	0.00263	2800	0.00219	2100	0.01750
1"	3800	0.00300	2500	0.00250	1800	0.02000

E

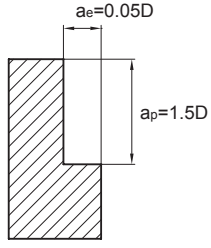
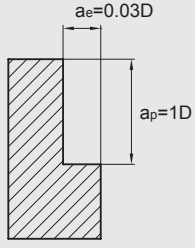
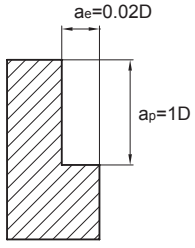
Workpiece material	Pre-hardened steel, Hardened steel 40~50HRC	Hardened steel 50~60HRC	Hardened steel 60~68HRC
Maximum cutting depth	 <p>Maximum <math>a_e=0.04</math>in</p>	 <p>Maximum <math>a_e=0.02</math>in</p>	 <p>Maximum <math>a_e=0.012</math>in</p>

- Please select high-precision and rigidity machine and tool holder.
- When the machine rigidity and workpiece fixture stability is low, vibration and abnormal noise may be generated. Please reduce the rotating speed and feed speed stated above correspondingly.
- Please use air blow or MQL (minimum oil mist cooling).
- Down milling is recommended in the case of side milling.
- Make overhang of tool as short as possible in conditions of non-interference.

### HMX-2B ★ HMX-2BL

Workpiece material	Pre-hardened steel, Hardened steel 40~50HRC		Hardened steel 50~60HRC		Hardened steel 60~68HRC	
	Rotating speed (r/min)	Feed speed (IPT)	Rotating speed (r/min)	Feed speed (IPT)	Rotating speed (r/min)	Feed speed (IPT)
1/32"	40000	0.00031	40000	0.00028	40000	0.00025
3/64"	40000	0.00047	40000	0.00042	40000	0.00038
1/16"	40000	0.00063	40000	0.00056	40000	0.00050
5/64"	40000	0.00078	40000	0.00070	3200	0.00063
3/32"	40000	0.00094	33000	0.00084	26700	0.00075
7/64"	34000	0.00109	28000	0.00098	22900	0.00088
1/8"	30000	0.00125	25000	0.00113	20000	0.00100
9/64"	26700	0.00141	22000	0.00127	17800	0.00113
5/32"	24000	0.00156	20000	0.00141	16000	0.00125
11/64"	21800	0.00172	18000	0.00155	14500	0.00138
3/16"	20000	0.00188	16600	0.00169	13300	0.00150
13/64"	18500	0.00203	15400	0.00183	12300	0.00163
7/32"	17200	0.00219	14300	0.00197	11400	0.00175
15/64"	16000	0.00234	13300	0.00211	10700	0.00188
1/4"	15000	0.00250	12500	0.00225	10000	0.00200
17/64"	14000	0.00266	11600	0.00239	9400	0.00213
9/32"	13400	0.00281	11100	0.00253	8900	0.00225
19/64"	12700	0.00297	10500	0.00267	8400	0.00238
5/16"	12000	0.00313	10000	0.00281	8000	0.00250
21/64"	11500	0.00328	9500	0.00295	7600	0.00263
11/32"	11000	0.00344	9100	0.00309	7300	0.00275
23/64"	10500	0.00359	8750	0.00323	7000	0.00288
3/8"	10000	0.00375	8300	0.00338	6600	0.00300
25/64"	9600	0.00391	8000	0.00352	6400	0.00313
13/32"	9200	0.00406	7600	0.00366	6100	0.00325
27/64"	8900	0.00422	7400	0.00380	5900	0.00338
7/16"	8600	0.00438	7100	0.00394	5700	0.00350
29/64"	8300	0.00453	6900	0.00408	5500	0.00363
15/32"	8000	0.00469	6600	0.00422	5300	0.00375
31/64"	7800	0.00484	6500	0.00436	5100	0.00388
1/2"	7500	0.00500	6250	0.00450	5000	0.00400
9/16"	6700	0.00563	5500	0.00506	4400	0.00450
5/8"	6000	0.00625	5000	0.00563	4000	0.00500
11/16"	5500	0.00688	4500	0.00619	3600	0.00550
3/4"	5000	0.00750	4100	0.00675	3300	0.00600
7/8"	4300	0.00875	3500	0.00788	2800	0.00700
1"	3800	0.01000	3100	0.00900	2500	0.00800

E

Workpiece material	Pre-hardened steel, Hardened steel 40~50HRC	Hardened steel 50~60HRC	Hardened steel 60~68HRC
Maximum cutting depth			

- Please select high-precision and rigidity machine and tool holder.
- Above table shows the standard for operations with little change of machining load, such as contour machining. When the machine rigidity and workpiece fixture stability is low, vibration and abnormal noise may be generated. Please reduce the rotating speed and feed speed stated above correspondingly.
- Please use air blow or MQL (minimum oil mist cooling).
- When inclination angle  $\alpha$  is more than  $15^\circ$ , please reduce rotating speed and feed speed to 50%~80% of the speeds stated in the table.
- Make overhang of tool as short as possible in conditions of non-interference.

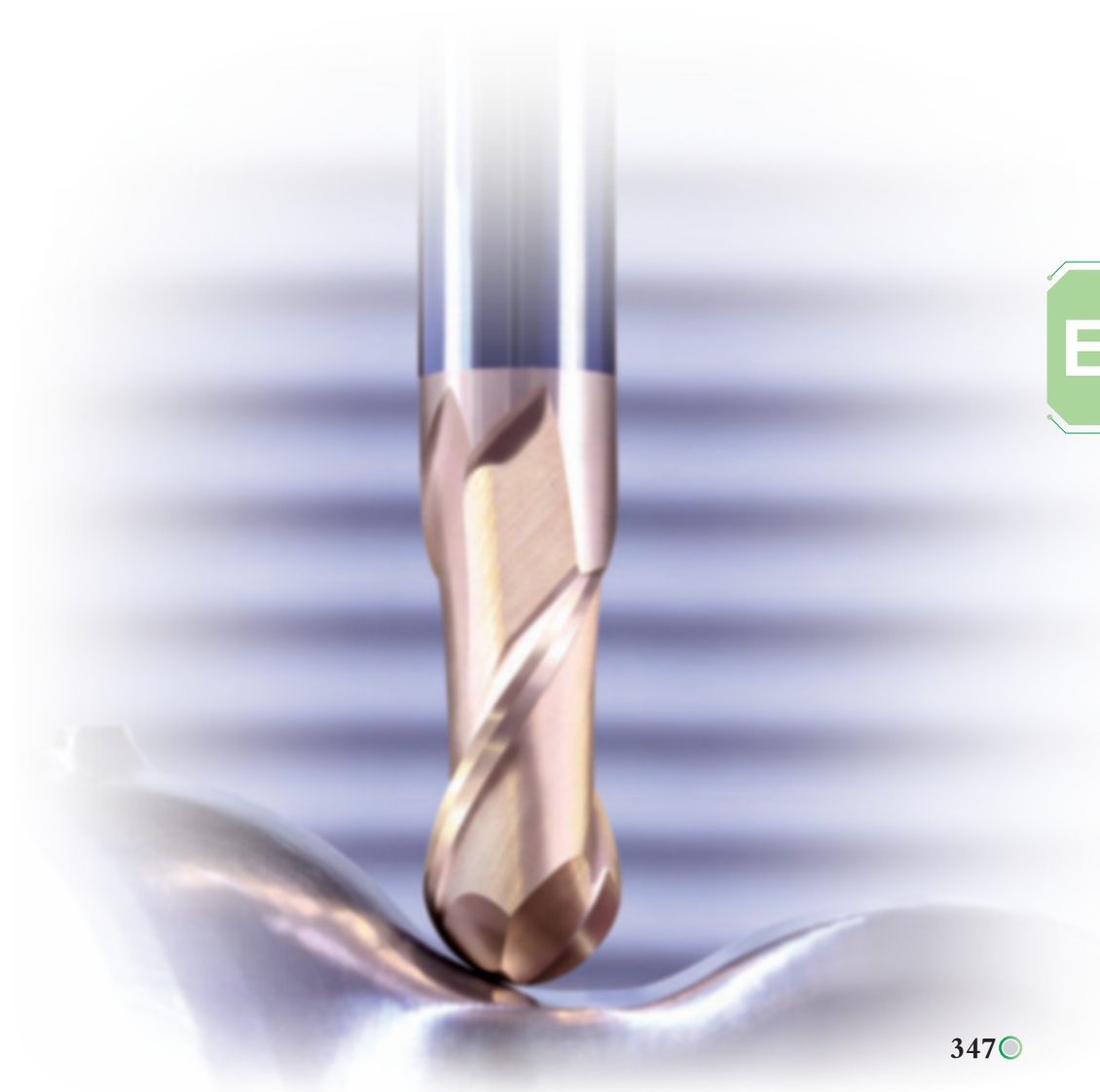

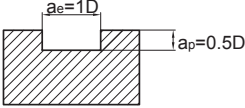
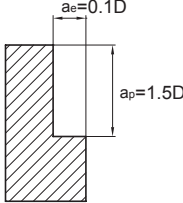

### Cutting data of AL series flattened end mills

Workpiece materials	Aluminum alloy		Silicon aluminum alloy si≤10%	
	Rotation speed (r/min)	Feed (IPT)	Rotation speed (r/min)	Feed (IPT)
1/16"	50000	0.00016	30000	0.00016
3/32"	33000	0.00024	20000	0.00024
1/8"	25000	0.00032	15000	0.00032
5/32"	20000	0.00048	12000	0.00048
3/16"	16600	0.00064	10000	0.00064
7/32"	14200	0.0008	8500	0.0008
1/4"	12400	0.00096	7500	0.00096
9/32"	11000	0.00112	6600	0.00112
5/16"	10000	0.0012	6000	0.0012
3/8"	8300	0.0016	5000	0.0016
7/16"	7100	0.002	4300	0.002
1/2"	6200	0.0022	3700	0.0022
9/16"	5500	0.0024	3300	0.0024
Max cutting data	Maximum stock removal in milling grooves (Feed speed 100%)			
				

- The above table shows the reference value of side milling. The feed speed in slot milling is 70% of the reference value stated in the table.
- Please select high rigidity and precision machine and tool holder. Vibration and abnormal noise may be generated if the machine rigidity and workpiece fixture stability is low. Please reduce the rotating speed and feed speed stated above correspondingly.
- It is possible to increase the rotating speed and feed speed correspondingly if the cutting depth is low.
- Please use water-soluble cutting liquid.
- Down milling is recommended in the case of side milling.
- Make overhang of tool as short as possible in conditions of non-interference.

### Cutting data of AL series ball nose end mills

Workpiece materials	Aluminum alloy		Silicon aluminum alloy si≤10%	
	Rotation speed (r/min)	Feed (IPT)	Rotation speed (r/min)	Feed (IPT)
1/8"	25000	0.0024	20000	0.002
3/16"	17000	0.004	13000	0.0032
1/4"	12500	0.0048	10000	0.004
5/16"	10000	0.0064	8000	0.0056
1/2"	6200	0.01	5000	0.008
5/8"	5000	0.0128	4000	0.01
3/4"	4200	0.016	3400	0.0128
Max cutting data				

- Please select high rigidity and precision machine and tool holder. Vibration and abnormal noise may be generated if the machine rigidity and workpiece fixture stability is low. Please reduce the rotating speed and feed speed stated above correspondingly.
- If the cutting depth is low, it is possible to increase the rotating speed and feed speed correspondingly.
- Please use water-soluble cutting liquid.
- Make overhang of tool as short as possible in conditions of non-interference.

### AL-2R-AIR

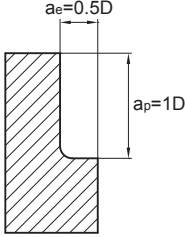
Workpiece material	Aluminum alloy		Silicon aluminum alloy Si≤10%	
Cutting speed	1650-2600SFPM		1650-2600SFPM	
Cutting edge diameter (inch)	Rotation speed (r/min)	Feed speed (in/min)	Rotation speed (r/min)	Feed speed (in/min)
1/2"	18000	169.291	18000	169.291
5/8"	15000	188.976	15000	188.976
3/4"	12000	216.535	12000	216.535
Maximum cutting depth	 <p>The diagram illustrates the maximum cutting depth parameters for the end mill. It shows a cross-section of a workpiece being machined. The cutting edge diameter is labeled as <math>a_e = 0.5D</math>, and the maximum cutting depth is labeled as <math>a_p = 1D</math>.</p>			

- This cutting condition is only used on the specific CNC machine for high speed aluminum alloy machining.
- Please ensure on using air blow or cutting liquid for chips evacuation.
- Caution on fire-The sparks on machining and heating of wears may cause the flammability and fire.
- The measurement of rotation balance is compulsory before the machining.

### Cutting data of UM series flattened end mills

Workpiece material	Carbon steel, Alloy steel		Stainless steel		Heat resistant alloy, Ti alloy	
	Rotating speed (r/min)	Feed speed (in/min)	Rotating speed (r/min)	Feed speed (in/min)	Rotating speed (r/min)	Feed speed (in/min)
5/32"	19900	78.35	15920	62.59	11940	47.05
3/16"	15920	68.89	12730	55.11	9550	37.4
15/64"	13260	66.92	10600	53.54	7960	36.61
5/16"	9950	66.14	7960	52.76	5970	36.61
25/64"	7960	65.35	6370	52.36	4775	35.83
15/32"	6630	65.35	5300	52.36	3980	35.83
9/16"	5685	61.02	4550	48.82	3410	33.46
5/8"	4975	61.02	3980	48.82	2985	33.46
25/32"	3980	61.02	3180	48.82	2390	33.46
Maximum cutting depth						

- The above table shows the standard value of side milling. When milling slot, rotating speed is around 80%~100% of the stated value, and feed speed around 60%~80%.
- Non water-soluble cutting liquid is recommended in machining of stainless steel heat-resistant alloy and Ti alloy.
- Please select high rigid and precise machine and tool holder.
- Adjust rotating speed and feed speed according to cutting depth and machine rigidity.
- Down milling is recommended in the case of side milling.
- Make overhang of tool as short as possible in conditions of non-interference.



### UM-4R (Standard)

Workpiece material	Cast iron, Carbon steel, Alloy steel ~30HRC		Quenched and tempered steel ~40HRC		Quenched and tempered steel ~45HRC		Quenched and tempered steel ~50HRC		Quenched and tempered steel ~55HRC	
	Rotating speed (r/min)	Feed speed (in/min)	Rotating speed (r/min)	Feed speed (in/min)	Rotating speed (r/min)	Feed speed (in/min)	Rotating speed (r/min)	Feed speed (in/min)	Rotating speed (r/min)	Feed speed (in/min)
1/8"	9900	141.73	7900	102.36	6800	91.34	4800	59.06	2800	23.62
1/4"	5300	165.35	4250	120.47	3700	105.12	3650	67.32	1600	27.17
5/16"	4550	165.35	3200	120.47	2800	105.12	2000	67.32	1200	27.17
3/8"	3200	165.35	2550	120.47	2250	105.12	1600	67.32	955	27.17
1/2"	2650	165.35	2100	120.47	1850	105.12	1350	67.32	795	27.17
5/8"	2200	137.20	1745	100.00	1535	87.20	1140	55.91	660	22.44
3/4"	1825	113.98	1450	83.07	1275	72.44	960	46.46	550	18.70
Maximum cutting depth	Maximum $a_p=0.02$ in						Maximum $a_p=0.016$ in		Maximum $a_p=0.008$ in	
	<p>The diagram illustrates the maximum cutting depth parameters for a ball nose end mill. It shows a cross-section of the tool cutting into a workpiece. The axial cutting depth is labeled as <math>a_e=0.5D</math>, where <math>D</math> is the tool diameter. The radial cutting depth is labeled as <math>a_p=0.2R</math>, where <math>R</math> is the tool radius.</p>									

- Please select high-precision machine and tool holder.
- Please use air blow or cutting liquid with high mist retardant property.
- Down milling is recommended.
- When the machine rigidity and workpiece fixture stability is low, vibration and abnormal noise may be generated. Please reduce the rotating speed and feed speed stated above correspondingly.
- Make overhang of tool as short as possible in conditions of non-interference.
- The above cutting parameters are based on contour machining when overhang  $L/D \leq 4$ . Please make adjustments according to the table below when overhang is different.

#### Different cutting parameters under different overhang of tool:

Overhang	Cutting speed (SFPM)	Axial cutting depth (in)	Feed speed (in/min)
$L/D \leq 4$	100%	100%	100%
$L/D=5$	60%~80%	60%~80%	60%~80%
$L/D=6$	40%~60%	40%~60%	40%~60%

### UM-4R (High speed)

Workpiece material	Cast iron, Carbon steel, Alloy steel ~30HRC		Quenched and tempered steel ~40HRC		Quenched and tempered steel ~45HRC		Quenched and tempered steel ~50HRC		Quenched and tempered steel ~55HRC	
	Rotating speed (r/min)	Feed speed (in/min)	Rotating speed (r/min)	Feed speed (in/min)	Rotating speed (r/min)	Feed speed (in/min)	Rotating speed (r/min)	Feed speed (in/min)	Rotating speed (r/min)	Feed speed (in/min)
1/8"	19000	295.28	19000	271.65	14000	204.72	14000	185.04	9500	78.74
1/4"	10600	330.71	10600	300.00	7950	225.59	7950	203.15	5300	89.76
5/16"	7950	330.71	7950	300.00	5950	225.59	5950	203.15	4000	89.76
3/8"	6350	330.71	6350	300.00	4750	225.59	4750	203.15	3200	89.76
1/2"	5300	330.71	5300	300.00	4000	225.59	4000	203.15	2650	89.76
5/8"	3980	274.41	3980	248.82	2985	187.20	2985	168.50	1990	74.41
3/4"	3185	227.76	3185	206.50	2385	155.31	2385	139.76	1590	61.81
Maximum cutting depth	Maximum $a_p=0.016$ in						Maximum $a_p=0.008$ in		Maximum $a_p=0.004$ in	
	<p>The diagram illustrates the maximum cutting depth parameters for a ball end mill. It shows a cross-section of the tool cutting into a workpiece. The axial cutting depth is labeled as <math>a_e=0.3D</math>, where <math>D</math> is the diameter of the tool. The radial cutting depth is labeled as <math>a_p=0.2R</math>, where <math>R</math> is the radius of the tool.</p>									

- Please select high-precision machine and tool holder.
- Please use air blow or cutting liquid with high mist retardant property.
- Down milling is recommended.
- When the machine rigidity and workpiece fixture stability is low, vibration and abnormal noise may be generated. Please reduce the rotating speed and feed speed stated above correspondingly.
- Make overhang of tool as short as possible in conditions of non-interference.
- The above cutting parameters are based on contour machining when overhang  $L/D \leq 4$ . Please make adjustments according to the table below when overhang is different.

#### Different cutting parameters under different overhang of tool:

Ratio of neck length to diameter	Cutting speed (SFPM)	Axial cutting depth (in)	Feed speed (in/min)
$L/D \leq 4$	100%	100%	100%
$L/D=5$	60%~80%	60%~80%	60%~80%
$L/D=6$	40%~60%	40%~60%	40%~60%

### VSM-4E ★ VSM-4EL ★ VSM-4EFP

Workpiece material	Carbon steel, Alloy steel		Stainless steel		Heat resistant alloy, Ti alloy	
	Rotating speed (r/min)	Feed speed (in/min)	Rotating speed (r/min)	Feed speed (in/min)	Rotating speed (r/min)	Feed speed (in/min)
1/8"	6400	25.59	3700	5.51	3055	2.76
3/16"	5800	27.95	3000	7.48	2470	3.54
1/4"	5300	29.53	2700	7.87	2470	4.72
5/16"	3900	27.56	2000	8.27	1820	5.12
3/8"	3100	25.20	1600	8.27	1430	5.12
1/2"	2600	23.62	1300	6.69	1235	4.33
5/8"	1900	20.47	1000	5.91	935	3.54
3/4"	1500	17.52	800	5.51	740	3.54
1"	1250	15.75	600	4.72	550	3.15
Maximum cutting depth						

- Above table shows the standard value of side milling. When milling slot, 80%~100% of rotating speed and 60%~80% of feed speed stated above are recommended as standard.
- When cutting stainless steel, titanium alloy and heat resistant alloy, non- water soluble cutting fluid is recommended.
- Please select high rigidity, high precision machine tools and tool holders.
- Adjust machine's rigidity speed and feed rate based on the depth of cut and machine's rigidity.
- Climb milling recommended.
- Make overhang of the tool as short as possible under the conditions of non-interference.
- Table above is based on the recommended value of  $L/D \leq 4$ . When  $L/D > 4$ , reduce both rotating and feed speed down to 70%.

E

### VSM-4R ★ VSM-4RL ★ VSM-4RFP

Workpiece material	Carbon steel, Alloy steel		Stainless steel		Heat resistant alloy, Ti alloy	
	Rotating speed (r/min)	Feed speed (in/min)	Rotating speed (r/min)	Feed speed (in/min)	Rotating speed (r/min)	Feed speed (in/min)
1/8"	6400	31.50	3700	7.87	3055	4.72
3/16"	5800	33.46	3000	8.66	2470	5.12
1/4"	5300	35.43	2700	9.45	2470	5.71
5/16"	3900	33.07	2000	10.04	1820	6.10
3/8"	3100	30.31	1600	10.04	1430	6.10
1/2"	2600	28.35	1300	8.07	1235	5.31
5/8"	1900	24.61	1000	7.09	935	4.33
3/4"	1500	21.65	800	6.50	740	3.94
1"	1250	18.90	600	5.71	550	3.54
Maximum cutting depth						

- Above table shows the standard value of side milling. When milling slot, 80%~100% of rotating speed and 60%~80% of feed speed stated above are recommended as standard.
- When cutting stainless steel, titanium alloy and heat resistant alloy, non- water soluble cutting fluid is recommended.
- Please select high rigidity, high precision machine tools and tool holders.
- Adjust machine's rigidity speed and feed rate based on the depth of cut and machine's rigidity.
- Climb milling recommended.
- Make overhang of the tool as short as possible under the conditions of non-interference.
- Table above is based on the recommended value of  $L/D \leq 4$ . When  $L/D > 4$ , reduce both rotating and feed speed down to 70%.